



BX2257

2011-13 Honda Accord Crosstour EX-L Installation Instructions

Attachment Tab Height: 14"

Attachment Tab Width: 22"

Serial Number

Please read BOTH these Installation Instructions and the General Information sheet prior to installing or operating this equipment.

1. Blue Ox® towing products and accessories are intended to be installed by Blue Ox® Dealers who are familiar with our products and have the equipment necessary and knowledge to do "fit work". When necessary Blue Ox® Dealers can be found at www.blueox.com or by contacting our Customer Care Department at (402) 385-3051.
2. Many Blue Ox® Baseplates are designed to use existing holes and hardware to mount the baseplate to the towed vehicle. Even though bolts are there, do not assume they are adequate for baseplate mounting. Always use hardware supplied in the hardware kit and existing hardware specified in the Baseplate Installation Instructions.

Bolt Torque Specifications

Torque in Foot-Pounds for Inch Bolts

Bolt Size	Grade 5	Grade 8
1/4"	10	14
5/16"	19	29
3/8"	33	47
7/16"	54	78
1/2"	78	119
5/8"	154	230
3/4"	257	380

Bolt Torque Specifications

Torque in Foot-Pounds for Metric Bolts

Bolt Size	Grade 8.8	Grade 10.9
6MM	6	8
8MM	16	22
10MM	31	40
12MM	54	70
14MM	89	117
16MM	161	230
18MM	222	318



If the front of your vehicle looks different than this, call us at (402) 385-3051.

Reference your vehicle owner's manual for manufacturer's towing specifications.



WARNING

Failure to read and follow these instructions could result in separation of the towed vehicle from the tow bar, causing property damage, loss of towed vehicle, personal injury or death.

BX2257

2011-13 Honda Accord Crosstour EX-L

Installation Instructions

Tools Required

Large Vise Grip	Loctite® RED
Flat Screwdriver	13/32" Drill Bit
Phillips Screw Driver	10MM Socket
Torque Wrench	10MM Wrench
Reciprocating Saw	12MM Socket
Drill	9/16" Socket
Tape Measure	5/8" Wrench

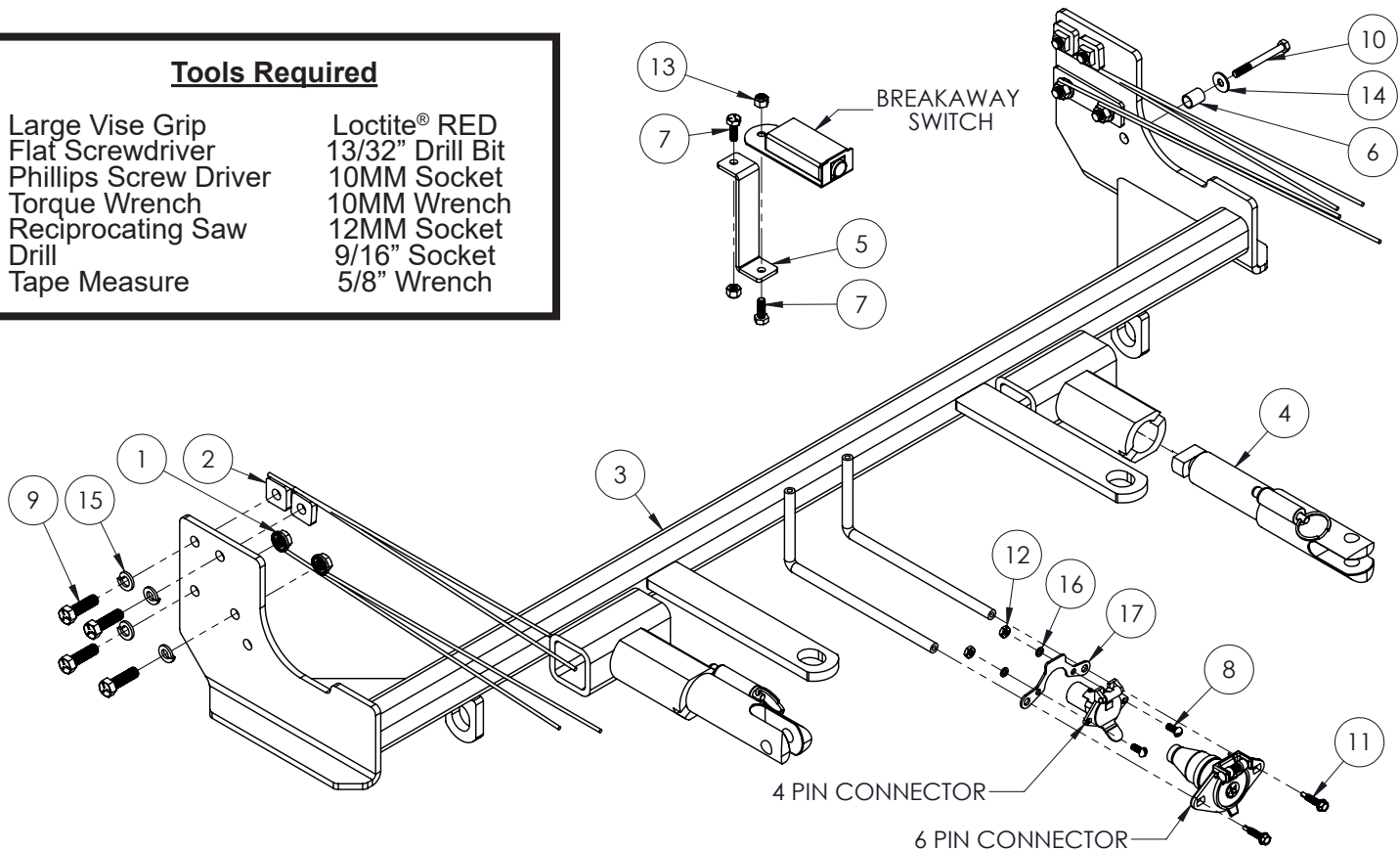

Item No.	Part No.	Description	Qty.
1.....	61-4978	3/8"-16 Whiz Nut w/ 14" Wire	4
2.....	61-5208	1/4" x 1" x 1" Nut Plate w/ 14" Wire	4
3.....	61-6932	BX2257 Baseplate.....	1
4.....	62-3469	Attachment Tab Assembly with Hole	2
5.....	102-7116	Breakaway Bracket	1
6.....	107-3081	1/2" OD x 18 GA W x .63" Tube.....	1
7.....	201-0050	1/4"-20 x 3/4" Hex Head Bolt, Grade 5, ZP	2
8.....	201-0192	#10-32 1/2" Round Slotted Head Screw.....	2
9.....	201-0368	3/8"-16 x 1-1/4" Hex Head Bolt, Grade 5.....	8
10.....	201-0798	6MM-1.0 x 60MM Hex Head Bolt, Grade 8.8, ZP.....	1
11.....	201-0979	#12-14 x 1" Self Drilling Screw, ZP.....	2
12.....	202-0047	#10-32 Hex Nut	2
13.....	202-0102	1/4"-20 Hex Nylon Nut, ZP	2
14.....	203-0001	1/4" Flat Washer, ZP.....	1
15.....	203-0010	3/8" Lock Washer, ZP	8
16.....	203-0054	#10 Lock Washer, ZP	2
17.....	299-0685	Electrical Bracket.....	1
18.....	226-0046(not shown)	Class III Safety Cables	2
19.....	229-0359(not shown)	3/8" Quicklink, ZP	2
20.....	290-0437(not shown)	Black Cap Plug Receiver.....	2

Important:

Use only genuine factory replacement parts on your baseplate. Do **NOT** substitute homemade or non-typical parts. If a bolt is lost or in need of replacement, for your safety and the preservation of your baseplate, be sure to use a replacement bolt of the same grade (In most cases it will be Grade 5, please reference the parts list above). Replacement parts may be ordered through your nearest Blue Ox® Dealer or Distributor, or call our Customer Care Team at (402)385-3051. Failing to follow and/or altering these installation instructions in either installation or required equipment will void the manufacturer's warranty. Towing behind a non-motorized vehicle will void the warranty.

BX2257
2011-13 Honda Accord Crosstour EX-L
Installation Instructions

Attachment Tabs: Motorhome mount tow bars are recommended for use with this baseplate. Due to the design of the removable tabs, the RangeFinderII tow bar can not be used. Adapters, except the BX8833 and BX88151, can not be used with this baseplate.

Installation Notes: The radiator cover, fascia, fog lights, bumper, and temperature sensor are removed for the baseplate installation. Drilling is required.

Some vehicles fascia's may need trimming. The dimensional variations between otherwise identical vehicles can be considerable. While the baseplate was designed for easy installation, it may be necessary to tailor the baseplate slightly to compensate for auto manufactures' tolerances. These minor adjustments may include filing a hole slightly, bending electrical rods or bending end plates.

The BX8869 Bulb and Socket Wiring Kit is recommended for this vehicle. (See page 6 for possible location.)

Installation Instructions

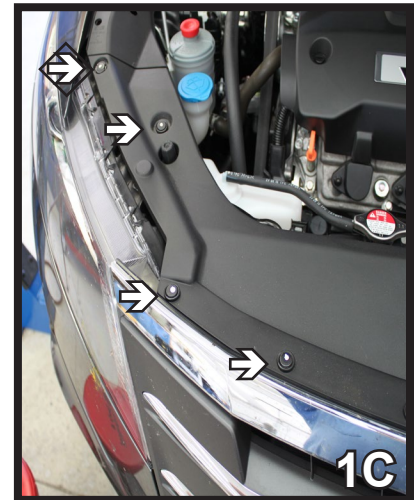
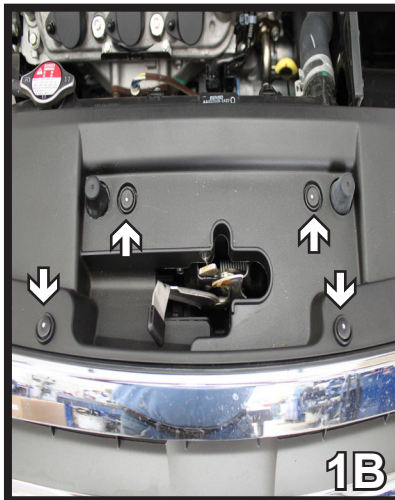
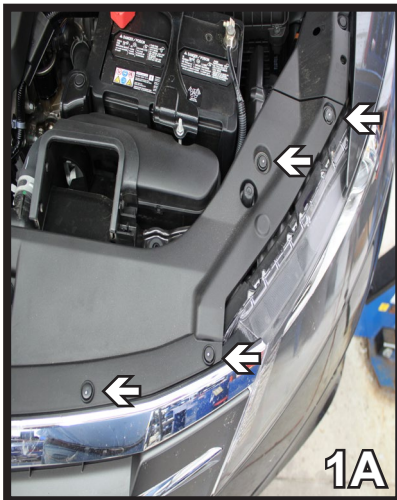

1. Remove twelve (12) push pins from the top of the fascia in order to remove the radiator cover. Remove radiator cover and set aside with the push pins to be reinstalled later.

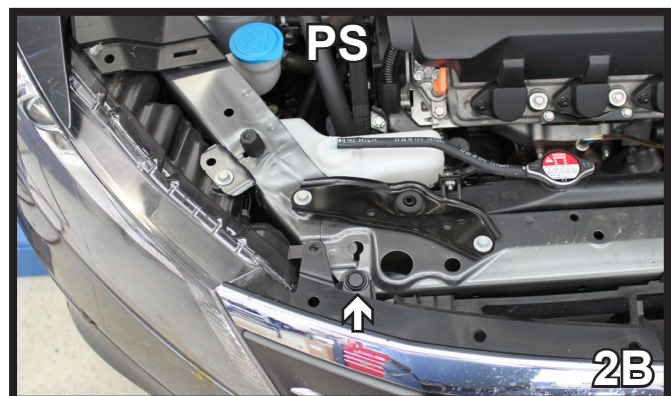

2. After radiator cover is removed, remove the two additional push pins just above each headlight. Set aside to be reinstalled later.

Handling of some cosmetic parts when installing this product may require the use of protective covers, rags, specialty tools, etc. to prevent damage.

Do not use the towed vehicle for storing luggage, equipment, etc. This may cause you to exceed the towing capacity of the tow bar, baseplate, and its accessories.

BX2257
2011-13 Honda Accord Crosstour EX-L
Installation Instructions

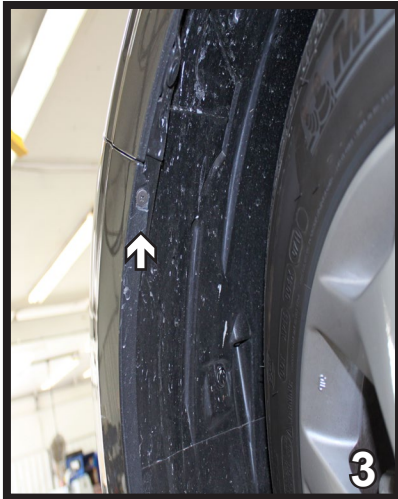

3. With a Phillips screwdriver, in front of the tire, remove one Phillips screw. Do this on both sides. Set aside screws to be reinstalled later.



4. Underneath the fascia, remove ten push pins all the way around. Set push pins aside to be reinstalled later (4A, 4B, 4C, 4D, 4E). Disconnect fog lights and remove fascia. Set fascia aside to be reinstalled later.

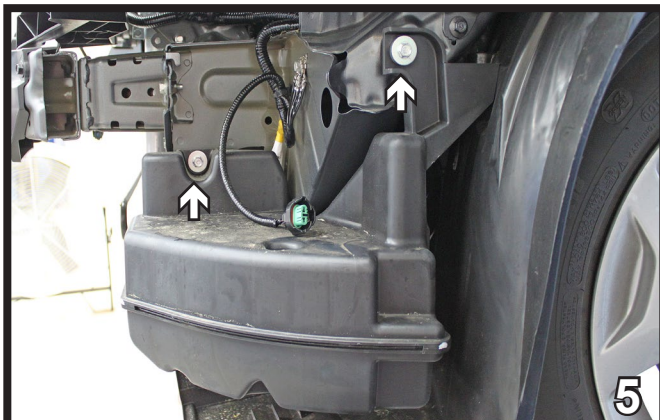
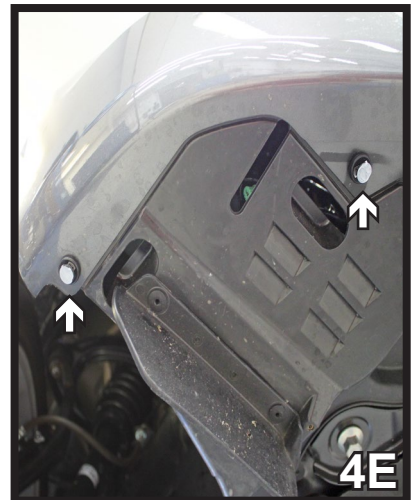
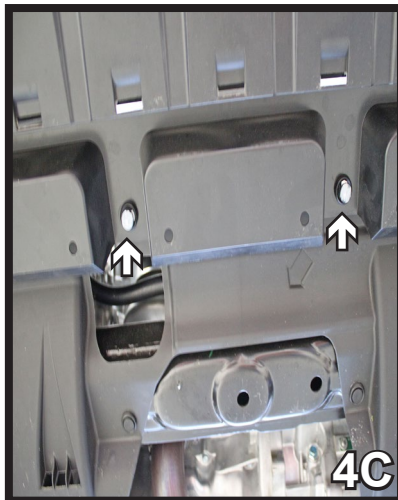

5. On the driver's side, use a 10MM socket to remove the two bolts holding the air baffle. Don't remove the air baffle, just pull it back out of the way. New bolts are provided for reinstallation of air baffle.

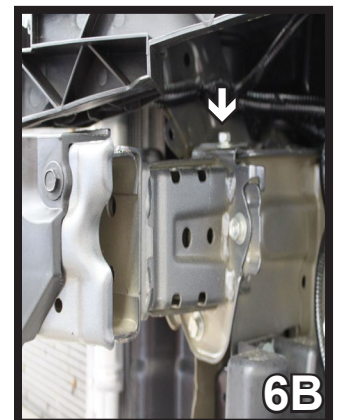
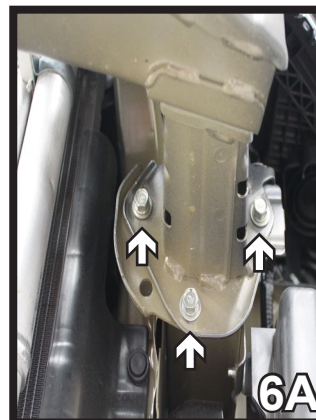

6. Using a 12MM socket, remove the four metric bolts holding the metal bumper. Do this on both sides. Set bolts aside to be reinstalled later.

BX2257
2011-13 Honda Accord Crosstour EX-L
Installation Instructions

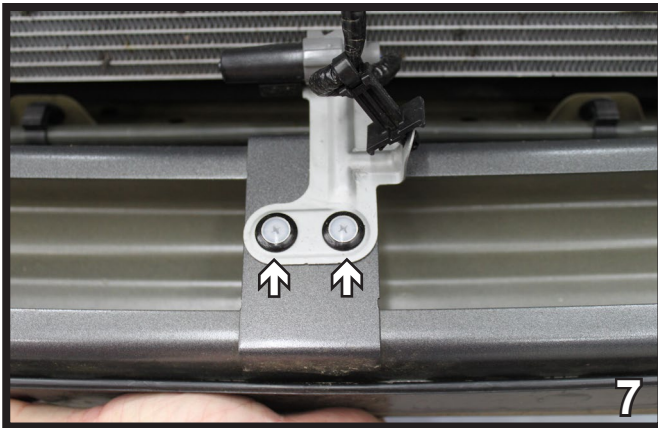

7. Behind the bumper, disconnect the temperature sensor by removing two push pins. Pull the metal bumper forward and set bumper and push pins aside to be reinstalled later.



8. Clamp the air bag sensor bracket with the vice grip and bend it back, flush with frame rail. Do this on both sides.

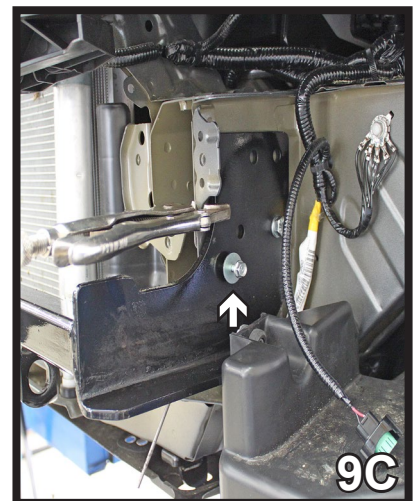
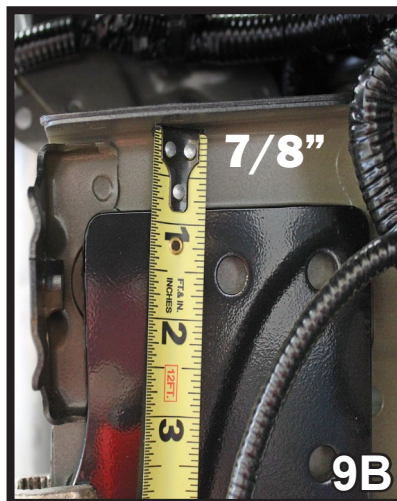

9. With the vehicle on a level surface, slide the baseplate up and in. The back of the baseplate should be flush with the frame. The existing bolt hole in the frame rail, as seen in 9A, should be lined up with your baseplate (driver's side only). Clamp with large vise grips (both sides). Be sure the baseplate is level with respect to the vehicle frame. The top of the baseplate should be approximately 7/8" down from the frame ledge as shown in 9B. Do this on both sides. Insert a 6MM-1.0 x 60MM hex bolt and 1/4" flat washer into the existing hole on driver's side frame rail as shown in 9C - **Do Not Tighten**.

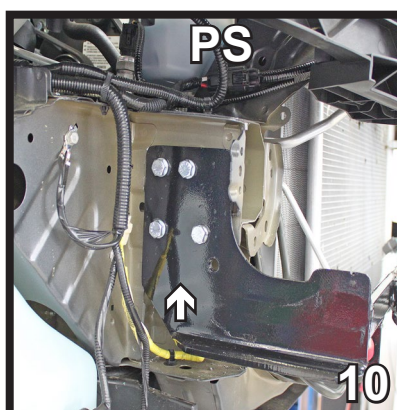
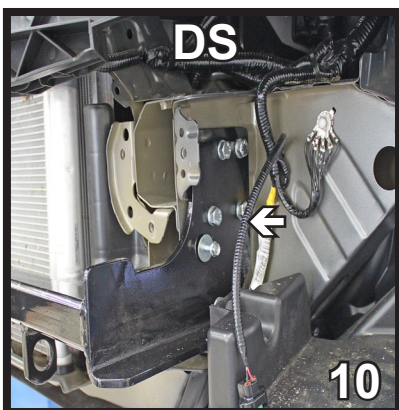

10. Using the baseplate as a template, with a 13/32 drill bit, drill through one of the remaining holes on each side. Insert 3/8-16 x 1 1/4" bolts and 3/8" lock washers in these holes to secure the baseplate for additional drilling in remaining holes. Drill remaining three holes on each side and insert the bolts and lock washers into these holes as well. The top two bolts attach to 3/8-16 nut plates inserted inside the frame. The bottom two bolts attach to 3/8-16 whiz nuts. Be sure to use Loctite Red on all the bolts.

BX2257
 2011-13 Honda Accord Crosstour EX-L
 Installation Instructions



11. Remove the inserted 6MM-1.0 x 60MM bolt and 1/4" flat washer from the baseplate to reattach the air baffle. Once air baffle is lined up with the existing holes, re-insert the 6MM-1.0 x 60MM bolt, 1/4" flat washer and the provided tube spacer in the bottom hole (white arrow). In the top hole, use #10-16 x 1 1/2" self-drilling screw and 1/4" flat washer (gray arrow).

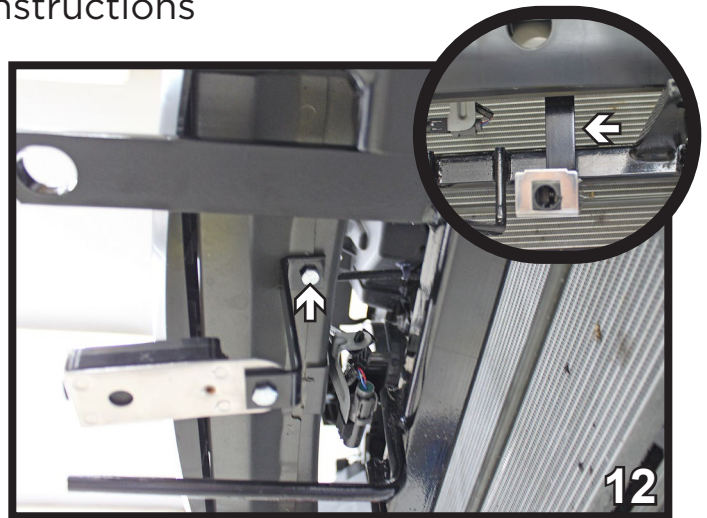

12. Reinstall the bumper and temperature sensor with existing bolts and pushpins.
OPTIONAL: Mount breakaway bracket to the bottom of the metal bumper. Using a 13/32" drill bit, drill a hole in the bottom of the bumper. Install breakaway bracket using a 1/4-20 x 3/4" bolt and 1/4-20 nut.



13. Attach the permanent baseplate safety cables to the provided convenience link on the baseplate (white arrow). The photo to the left shows the recommended installation of the cables to frame of vehicle (gray arrow). Additional options may interfere with suggested mounting; in this case, secure the cables to a solid piece of the frame as described in the instructions included with the permanent baseplate safety cables. Be sure the safety cables do not rub against any hoses or moving parts. Do this to both sides of the vehicle.

14. Reconnect fog lights and reinstall fascia using existing bolts and push pins. Reinstall radiator cover using existing push pins.



Possible location for Bulb and Socket Wiring Kit (BX8869)

Be sure that all electrical connections are plugged in properly and functioning Before installing the fascia.

When using power drills be aware of the dangers of torque and drill bit length.

Be sure to use loctite® red on all bolts before tightening. Tighten all bolts according to the torque chart on the front page of these instructions or on page 3 of the baseplate towing general instructions.

BX2257
2011-13 Honda Accord Crosstour EX-L
Installation Instructions

Install the tow bar and safety cables according to the instructions provided in their packages. When demonstrating this to the customer, be sure to include all the contents and packages.

Do **NOT** substitute other devices if the tow bar pins and clips are misplaced.



Shown without removable tabs installed.



Shown with removable tabs installed.

If the baseplate is in an accident, it must be replaced. DO NOT use it again! An accident can cause unseen damage and using it again could result in more damage or serious injury. DO NOT use the baseplate if it is damaged or missing parts.

CUSTOMER SERVICE COMMITMENT

Blue Ox® is committed to providing you with exceptional customer care throughout your lifetime with our products. Our team is here to assist you with any questions you may have regarding the performance of your product. Simply call (402) 385-3051 and you can speak with our technical service team.

Additionally, please visit our website to see which rallies our Destination America team will be attending. For a nominal fee, our service technician will service your towing system to ensure it's in proper working condition. Also, as a commitment to our customers, should you visit our factory, you can stay at our full service Blue Ox® campground at no charge along with enjoying a factory tour.

Again, thank you for being our customer and for the confidence you have shown in the performance of our products. It is because of customers like you we enjoy the success we have today.

© 2021 Blue Ox
One Mill Road, Industrial Park
Pender, Nebraska 68047
Phone: (402) 385-3051
Fax: (402) 385-3360
www.blueox.com

General Information

1. Ensure that your product(s) are registered online at www.blueox.com. It is crucial to register your product(s) so that you may be alerted of product offerings, updates, upgrades, maintenance and safety bulletins, and/or recalls.
2. **It is the owner's responsibility to inspect all towing equipment for cracked welds, missing or worn parts and loose bolts before each towing trip.** Be sure to use Loctite® Red on all bolts and tighten to the recommended specifications.
3. **It is the owner's responsibility to hook up all towing equipment per manufacturer's instructions/recommendations.**
4. Remove the attachment tabs when not in use (if applicable).

Notice To Baseplate Installer

1. It is YOUR responsibility to watch for:

- Oil cooler and air conditioner lines
- Electrical wires and hoses
- Missing parts or attaching points on the frame

** If the baseplate is improperly installed and is against a wire or hose, it could cause fluid leaks or electrical shorts some time after the actual baseplate installation.

Permanent Baseplate Safety Cable Installation

Permanent baseplate safety cables are strongly recommended when towing a vehicle with a tow bar. The principle function of the permanent baseplate safety cables is to prevent the towed vehicle from breaking loose in the event the connection between the frame of the towed vehicle and the baseplate fails or becomes disconnected. The cables must be connected from the baseplate to the frame rail or cross member of the vehicle's frame. The illustrations below show the possible arrangements recommended by Blue Ox®. Each permanent baseplate safety cable must have an adequate weight rating for the towing system. The weight rating of the two (2) cables together will not qualify.

Do not mount the permanent baseplate safety cables against wires, hoses or brake lines.

These permanent baseplate safety cables should remain installed as long as the baseplate is installed on the vehicle. Permanent baseplate safety cables are to be used in conjunction with, and NOT a replacement for legally required safety cables attaching the towed vehicle to the towing vehicle.

OPTION #1

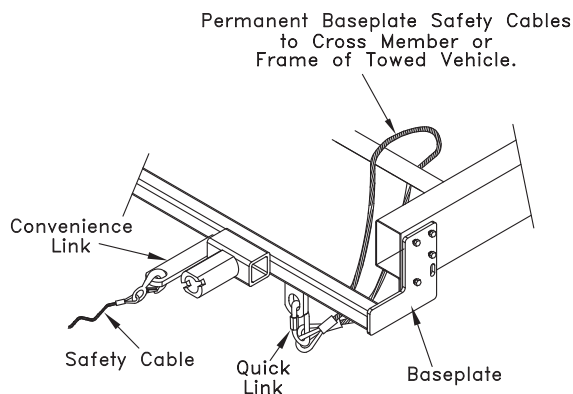

OPTION #2

