



## BX1980

# 2008-2010 Chrysler Town & Country 2008-2010 Dodge Caravan Installation Instructions

**Please read BOTH these Installation Instructions and the General Information sheet prior to installing or operating this equipment.**

- Blue Ox® towing products and accessories are intended to be installed by Blue Ox® Dealers who are familiar with our products and have the equipment and knowledge necessary to do “fit work”. If needed, Blue Ox® Dealers can be found at [www.blueox.com](http://www.blueox.com) or by contacting our Technical Service Department at (402) 385-3051.
- Many Blue Ox® baseplates are designed to use existing holes and hardware to mount the baseplate to the towed vehicle. Even though bolts are there, do not assume they are adequate for baseplate mounting. Always use the hardware supplied in the hardware kit and existing hardware as specified in the installation instructions.

### Serial Number

Attachment Tab Height: 13”

Attachment Tab Width: 17”

### Bolt Torque Specifications

Torque in Foot-Pounds for Inch Bolts

Bolt Size	Grade 5	Grade 8
1/4”	10	14
5/16”	19	29
3/8”	33	47
7/16”	54	78
1/2”	78	119
5/8”	154	230
3/4”	257	380

### Bolt Torque Specifications

Torque in Foot-Pounds for Metric Bolts

Bolt Size	Grade 8.8	Grade 10.9
6MM	6	8
8MM	16	22
10MM	31	40
12MM	54	70
14MM	89	117
16MM	161	230
18MM	222	318



If the front of your vehicle looks different than this, please contact us at (402) 385-3051.

## **WARNING**

Failure to read and follow these instructions could result in separation of the towed vehicle from the tow bar, causing property damage, loss of towed vehicle, personal injury or death.

**Reference your vehicle owner’s manual for manufacturer’s towing specifications.**

BX1980  
2008-2010 Chrysler Town & Country  
2008-2010 Dodge Caravan  
Installation Instructions

## Parts List

Ref. No.	Qty.	Part #	Description
1	1	61-6465	WLDM'T, BASEPLATE, BX1980
2	12	201-0368	3/8-16 X 1 1/4 HEX HEAD BOLT,GRD. 5
3	12	203-0010	3/8 LOCK WASHER, ZP
4	12	202-0003	3/8-16 HEX NUT, ZP
5	2	201-0979	#12-14 x 1" Self Drilling Screw, ZP
6	2	201-0192	#10-32 X 1/2 SLOT, RD. HD. SCREW
7	2	203-0054	#10 LOCK WASHER
8	2	202-0047	#10-32 HEX NUT
9	2	101-5822	ADAPTER, 4 WAY CONNECTOR
10	2	62-3468	ATT TAB ASSY, REM, SF/SB, 1 HOLE
	2	226-0046	BASEPLATE SAFETY CABLE, 36" CL III (NOT SHOWN)
	2	290-0437	RECEIVER, CAP PLUG (BLK) (NOT SHOWN)
	2	229-0359	QUICKLINK, 3/8, ZP (NOT SHOWN)

### Tools Required

10MM Socket  
9/16" Socket  
T20 Torx  
Reciprocating Saw  
Flat Screwdriver  
Phillips Screwdriver  
Utility Knife  
Tape Measure  
13/32" Drill Bit  
Loctite® RED

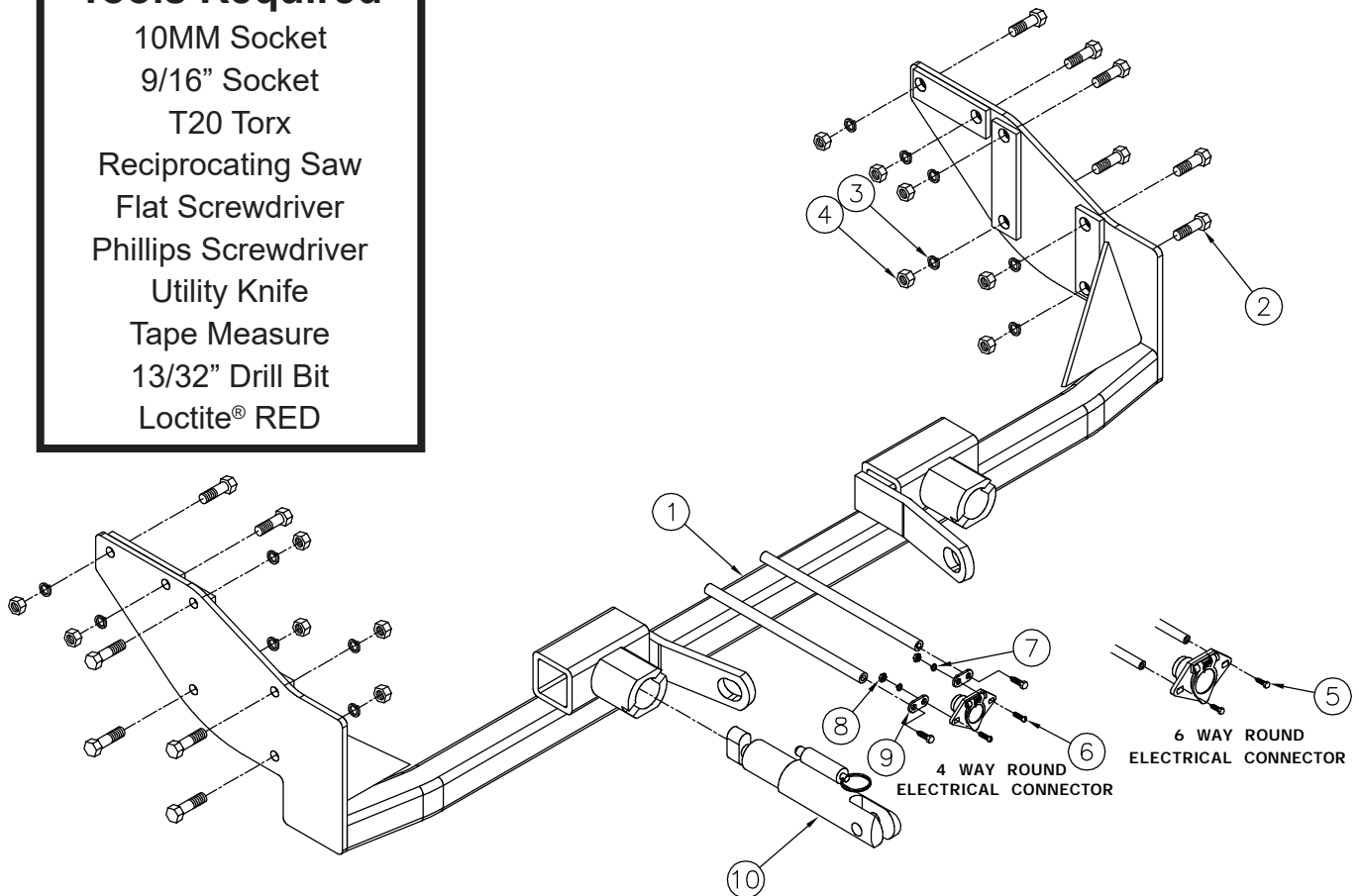

### Important:

Use only genuine factory replacement parts on your baseplate. Do **NOT** substitute homemade or non-typical parts. If a bolt is lost or in need of replacement, for your safety and the preservation of your baseplate, be sure to use a replacement bolt of the same grade (In most cases it will be Grade 5, please reference the parts list above). Replacement parts may be ordered through your nearest Blue Ox® Dealer or Distributor. Failing to follow and/or altering these installation instructions in either installation or required equipment will void the manufacturer's warranty.

BX1980  
2008-2010 Chrysler Town & Country  
2008-2010 Dodge Caravan  
Installation Instructions

### Vehicle Weight:

Motorhome mount tow bars are recommended for use with this baseplate. Due to the design of the removable tabs, the RangeFinderII and Ambassador tow bars can not be used. Adapters, except the BX8833 and BX88151, can not be used with this baseplate.

**Installation Notes:** The fascia is removed and reinstalled during installation of the baseplate. Drilling is required. Trimming of the fascia is required.

The dimensional variations between otherwise identical vehicles can be considerable. While the baseplate was designed for easy installation, it may be necessary to tailor the baseplate slightly to compensate for auto manufacturer's tolerances. These minor adjustments may include filing a hole slightly, bending electrical rods and/ or bending end plates.

The BX8869 Bulb and Socket Wiring Kit is recommended for this vehicle.

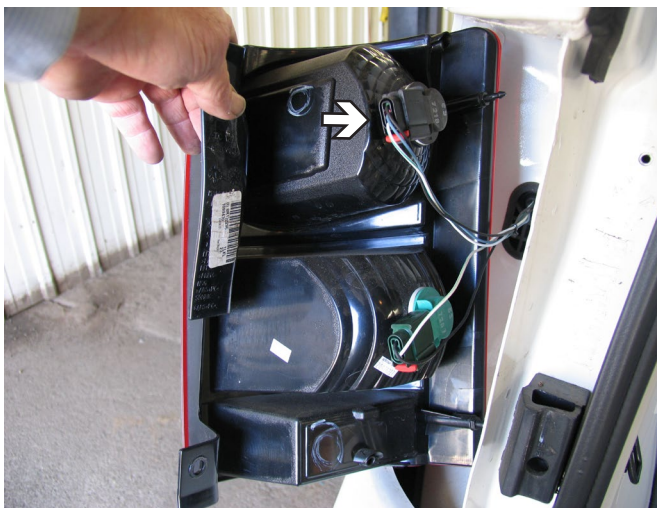

### Installation Instructions:

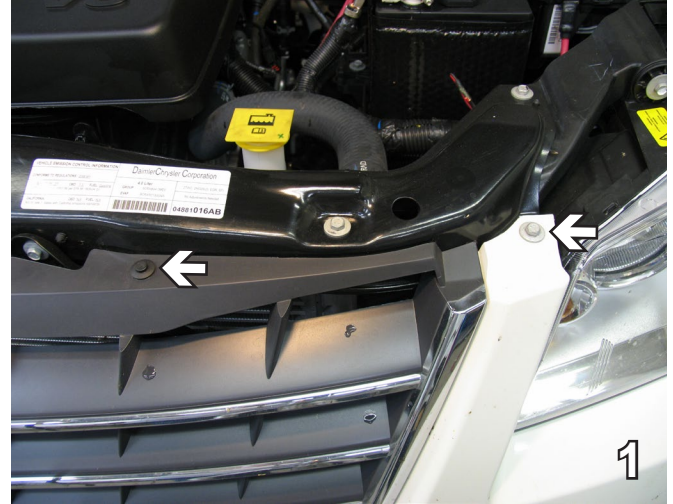

1. Using a 10MM socket remove the bolt above the headlight. Using a flat screwdriver remove the push pin. Do this to both sides and set bolts and push pins aside for later reinstallation.



- 2a. **Chrysler Town & Country:** Using a Phillips screwdriver, remove two push pins just forward of the front tire on the wheel well. Do this to both sides of the vehicle. Set push pins aside to be reinstalled later.
- 2b. **Dodge Caravan:** Using a T20 Torx, remove two push pins just forward of the front tire on the wheel well. Do this to both sides of the vehicle. Set push pins aside to be reinstalled later.

BX1980  
2008-2010 Chrysler Town & Country  
2008-2010 Dodge Caravan  
Installation Instructions

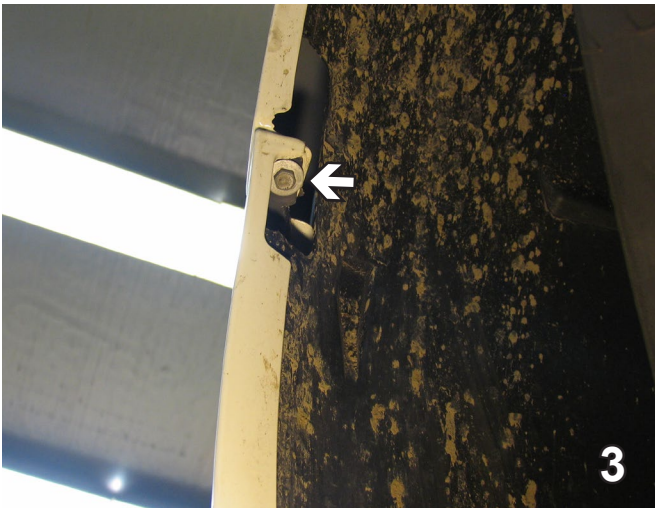

3. Continuing just forward of the front tire on the wheel well, using an 10MM socket, remove the bolt in the corner. Do to both sides and set bolt aside for later reinstallation.



4. On the driver side only, follow the fire wall around to the back, use a flat screwdriver to remove the push pin. Set the pin aside for later reinstallation.

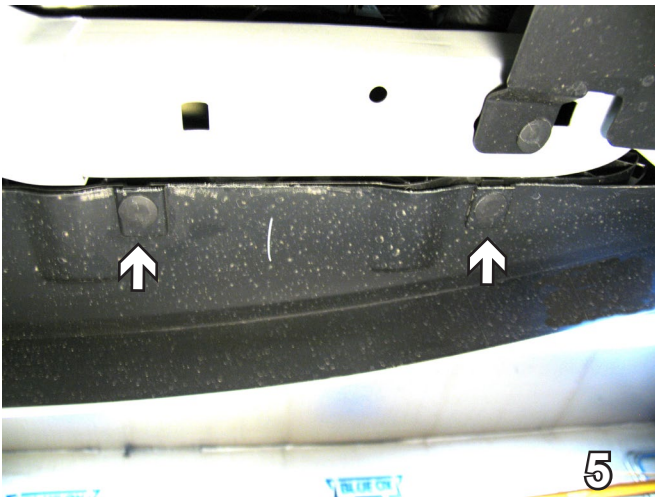

5. Using a flat screwdriver, remove four push pins from underneath the front edge of the fascia. Set push pins aside to be reinstalled later. The corner of the fascia is then pulled out to the side and forward to remove. Set fascia aside carefully to be reinstalled later. Be sure to unplug the fog lights.

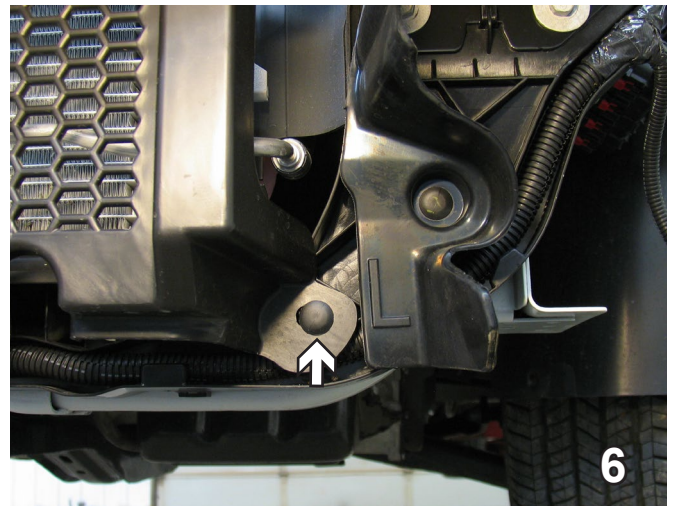

6. Using a flat screwdriver, remove the push pin on each side of the opening under the fascia.

BX1980  
2008-2010 Chrysler Town & Country  
2008-2010 Dodge Caravan  
Installation Instructions

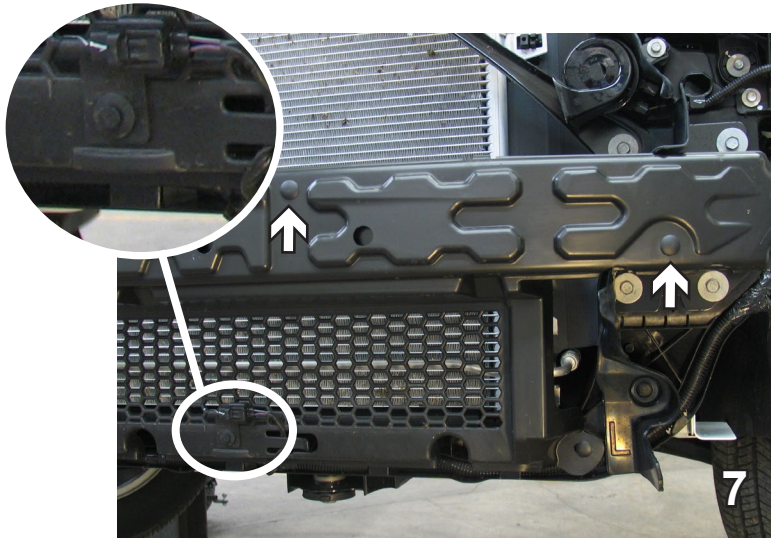

7. Using a flat screwdriver, remove the push pin from the air temperature control and let it hang (see arrow in inset). Continue removing four more push pins across the top. Remove the plastic cover.

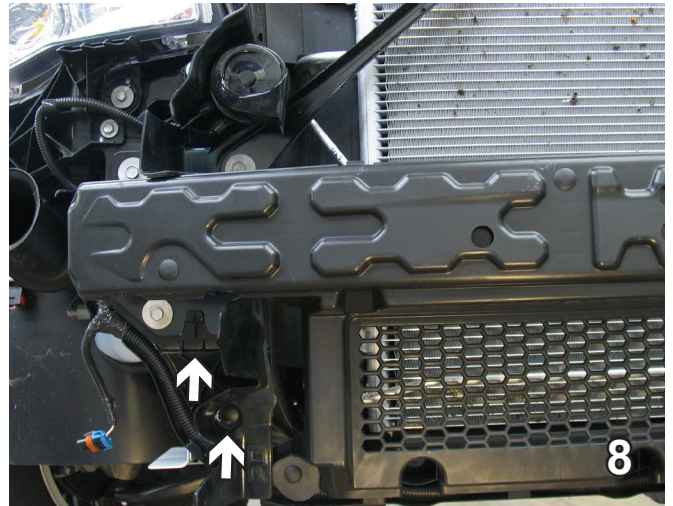

8. Using a flat screwdriver, remove the push pin. Then using a utility knife, cut the loose plastic right along the bumper. Do this to both sides.

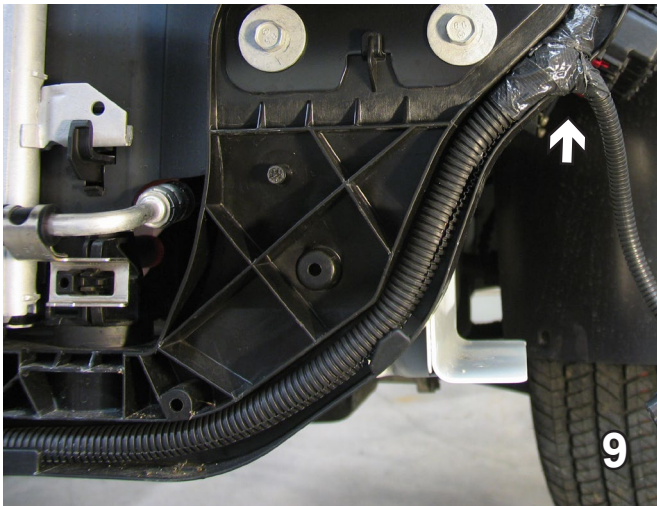

9. On the driver's side, pull out the push pin clip and take the wire harness out.

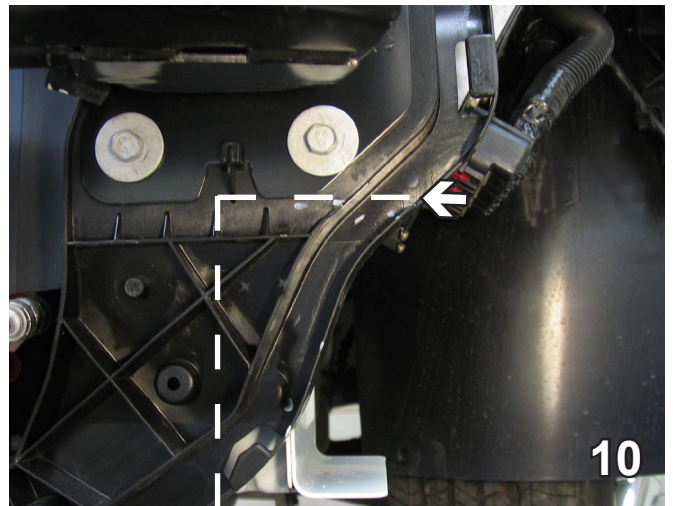

10. Using a utility knife, cut straight across right along side the bottom of the plate and straight up to a 90° angle. Do this on both sides.

BX1980  
2008-2010 Chrysler Town & Country  
2008-2010 Dodge Caravan  
Installation Instructions

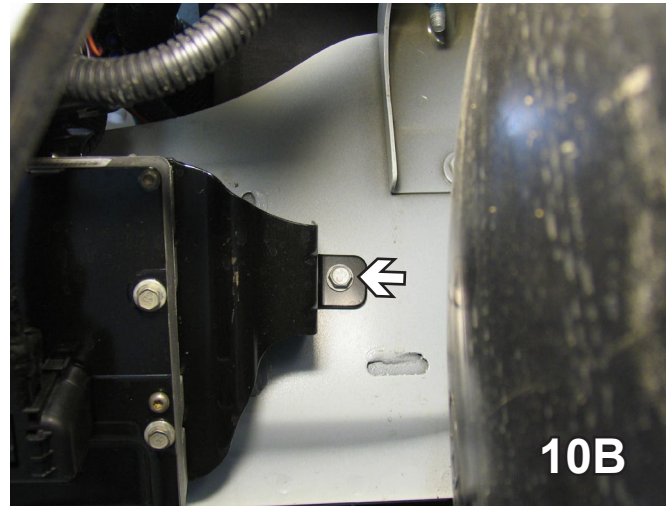
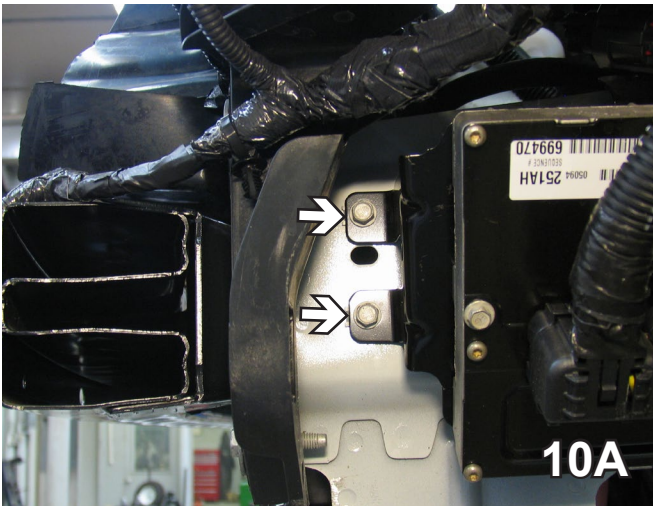

10. On the driver's side, using a 10MM socket remove two bolts on the front and one on the back then let the computer hang down in order to do drilling. Set bolts aside to be reinstalled later.

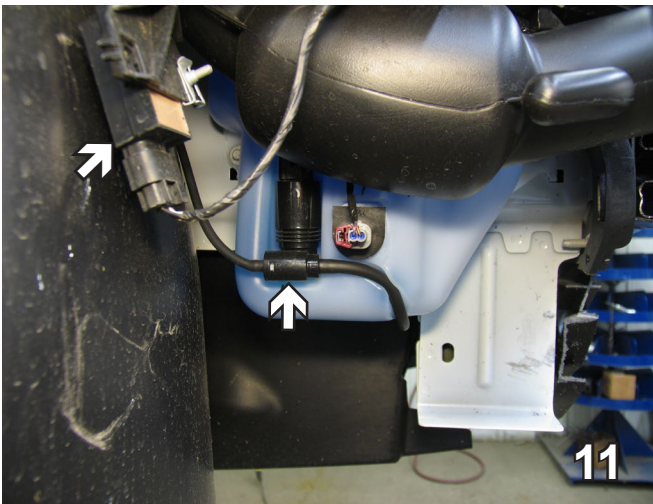

11. Unplug the electrical plug and take the water lines off the washer reservoir and plug them.

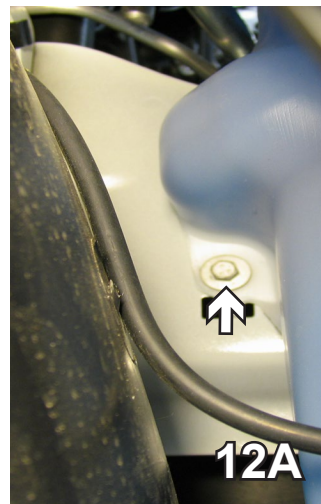

12. Using a 10MM socket, remove the two bolts one on each side of the washer reservoir. Set washer reservoir and bolts aside to be reinstalled later.

BX1980  
2008-2010 Chrysler Town & Country  
2008-2010 Dodge Caravan  
Installation Instructions

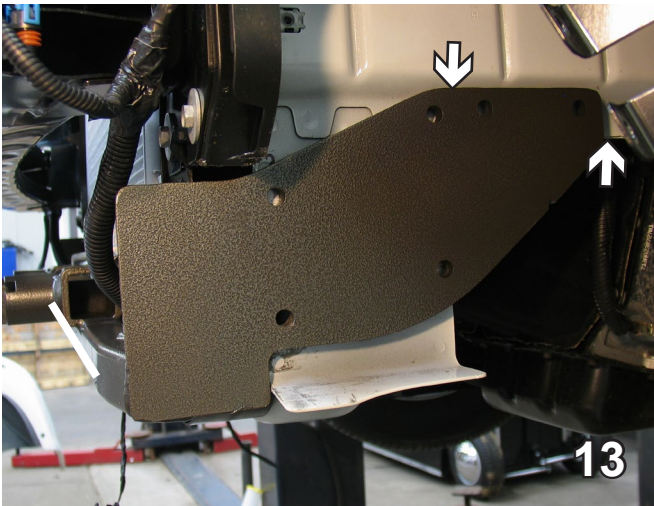

13. Slide the baseplate up where we cut and back as far as it will go. Be sure the baseplate is level.

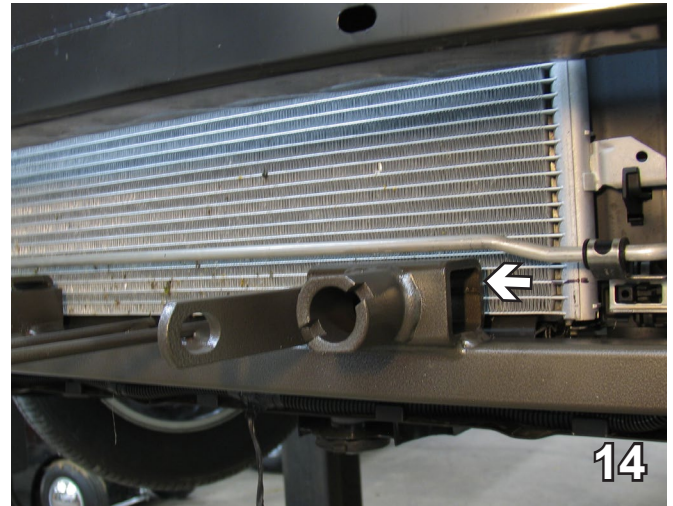

14. There is 1/2" gap between the line and the baseplate.

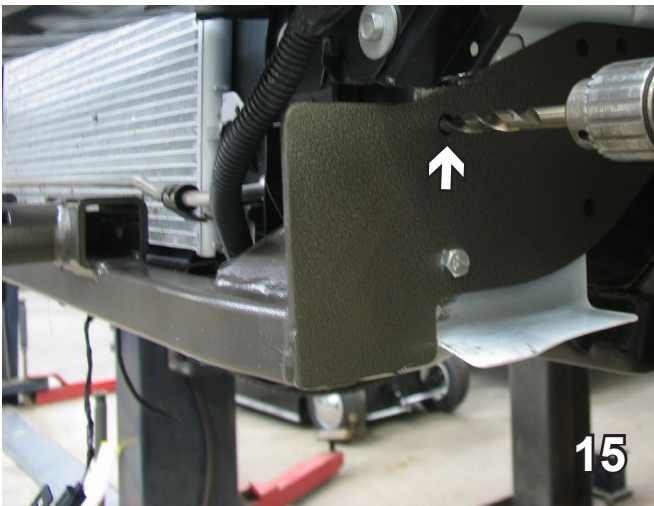

15. Using the baseplate as a template, drill six holes with a 13/32" drill bit.

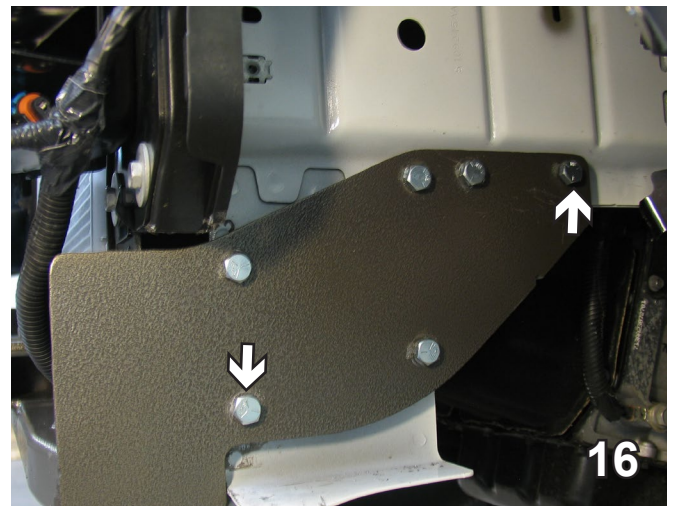

16. On the driver's side, mount the baseplate using 3/8" x 1 1/4" hex bolts going in and 3/8" lock washers and 3/8" hex nuts. Be sure to use LOCTITE Red on ALL bolts.

**BE SURE TO USE LOCTITE® RED ON ALL BOLTS BEFORE TIGHTENING. TIGHTEN ALL BOLTS ACCORDING TO THE TORQUE CHART ON THE FRONT PAGE OF THESE INSTRUCTIONS OR ON PAGE 3 OF THE BASEPLATE TOWING GENERAL INSTRUCTIONS.**

BX1980  
2008-2010 Chrysler Town & Country  
2008-2010 Dodge Caravan  
Installation Instructions

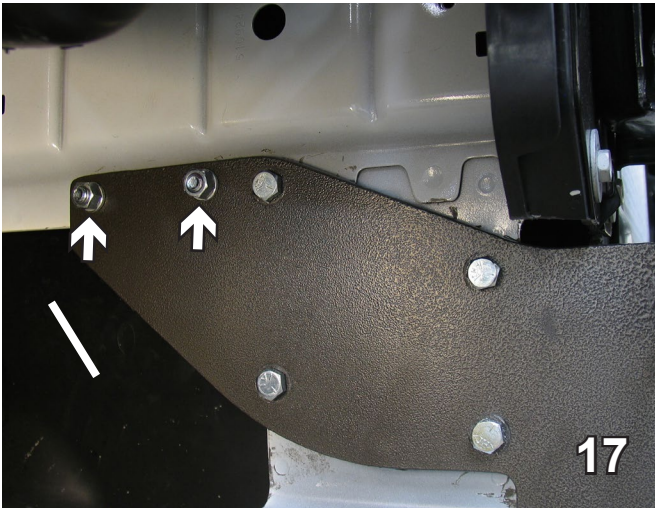

17. On the passenger's side, the top two bolts are brought from the inside out because of the black plastic shield. The same 3/8" x 1 1/4" hex bolts and 3/8" lock washers and 3/8" hex nuts are used. Be sure to use LOCTITE Red on ALL bolts.



18. Hold the plastic shield up to the front and with the utility knife cut out as needed for the baseplate tabs.

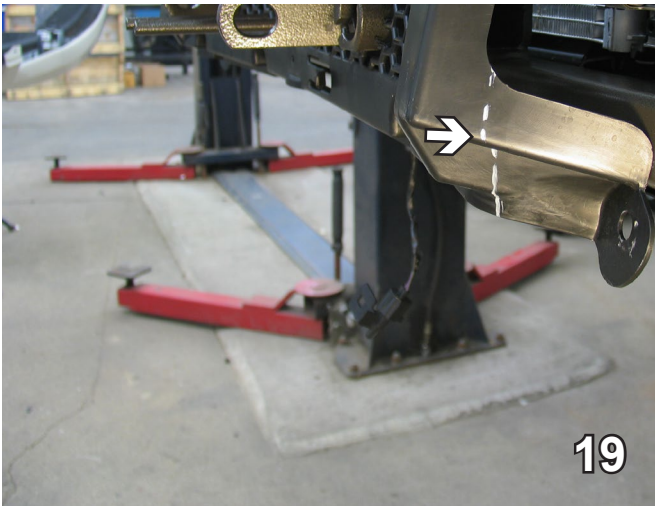

19. Using the utility knife cut 3" straight down on the corner of the plastic shield. Do this on both sides.

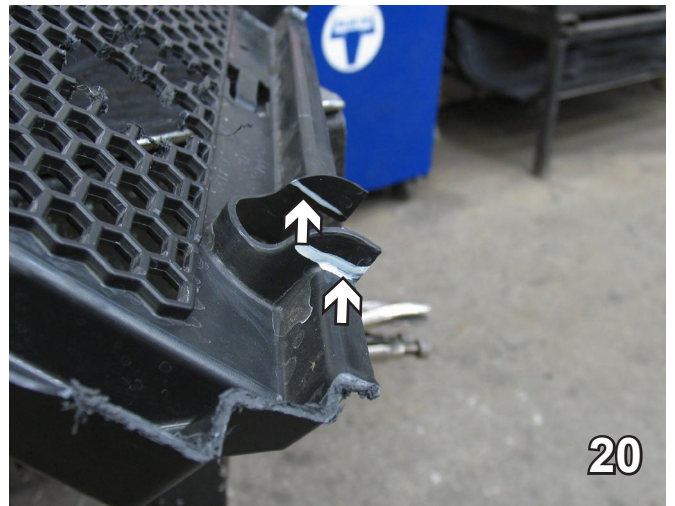

20. On the back side of the plastic shield, cut off the six tabs.



BX1980  
2008-2010 Chrysler Town & Country  
2008-2010 Dodge Caravan  
Installation Instructions

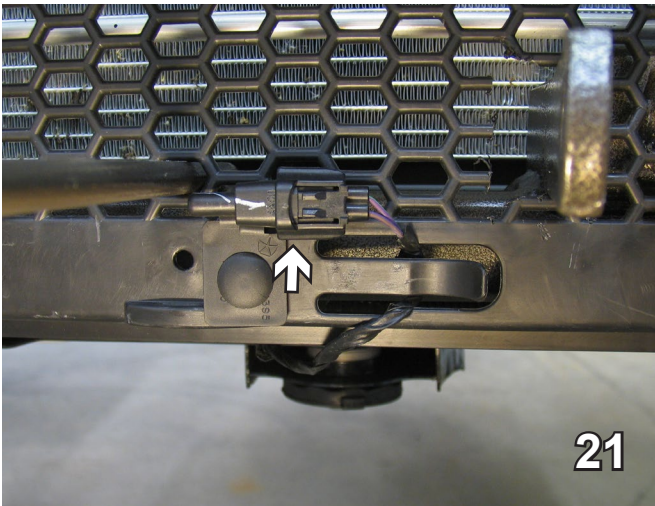

21. The air temperature control will not go back into the original hole. Hold it up and drill another hole.

Be sure that **ALL** electrical connections are plugged in properly and functioning **BEFORE** installing the fascia.

23. Replug the fog lights. Reinstall the fascia, computer and washer reservoir.

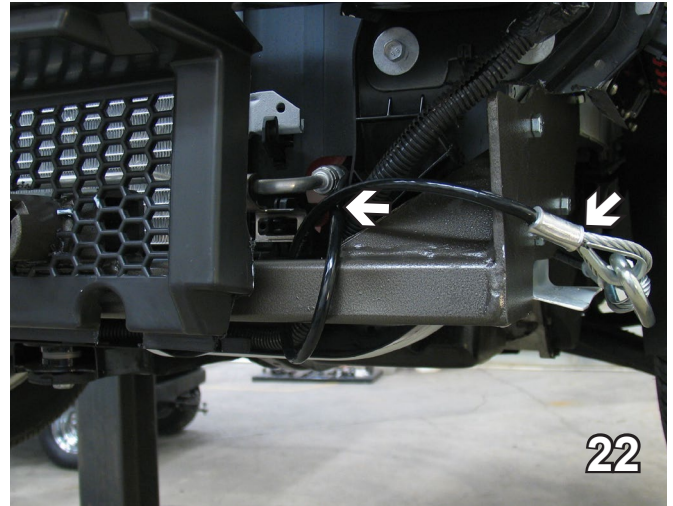

22. Attach the permanent baseplate safety cables to the provided convenience link on the baseplate (see grey arrow). The photo above shows the recommended installation of the cables to frame of vehicle (see white arrow). Additional options may interfere with suggested mounting; in this case secure the cables to a solid piece of the frame as described in the instructions included with the permanent baseplate safety cables. Be sure the safety cables do not rub against any hoses or moving parts. Do this to both sides of the vehicle.

BX1980  
2008-2010 Chrysler Town & Country  
2008-2010 Dodge Caravan  
Installation Instructions

Install the tow bar and safety cables according to the instructions provided in their packages. When demonstrating this to the customer, be sure to include all the contents and packages.

Do **NOT** substitute other devices if the tow bar pins and clips are misplaced.

**DEALER or INSTALLER:**  
**Be certain the user receives the instruction sheets for their products.**



If the baseplate is in an accident, it must be replaced. **DO NOT** use it again! An accident can cause unseen damage and using it again could result in more damage or serious injury. **DO NOT** use the baseplate if it is damaged or missing parts.

### CUSTOMER SERVICE COMMITMENT

Blue Ox is committed to providing you with exceptional customer care throughout your lifetime with our products. Our team is here to assist you with any questions you may have regarding the performance of your product. Simply call 1-800-385-3051 and you can speak with our customer care team.

Additionally, please visit our website to see which rallies our Destination America team will be attending. For a nominal fee, our service technician will service your towing system to ensure it's in proper working condition. Also as a commitment to our customers, should you visit our factory you can stay at our full service Blue Ox campground at no charge along with enjoying a factory tour.

Again thank you for being our customer and for the confidence you have shown in the performance of our products. It is because of customers like you we enjoy the success we have today.

© 2016 Blue Ox  
One Mill Road, Industrial Park  
Pender, Nebraska 68047  
Phone: (402) 385-3051  
Fax: (402) 385-3360  
[www.blueox.com](http://www.blueox.com)

# General Information

1. Ensure that your product(s) are registered online at [www.blueox.com](http://www.blueox.com). It is crucial to register your product(s) so that you may be alerted of product offerings, updates, upgrades, maintenance and safety bulletins, and/or recalls.
2. **It is the owner's responsibility to inspect all towing equipment for cracked welds, missing or worn parts and loose bolts before each towing trip.** Be sure to use Loctite® Red on all bolts and tighten to the recommended specifications.
3. **It is the owner's responsibility to hook up all towing equipment per manufacturer's instructions/recommendations.**
4. Remove the attachment tabs when not in use (if applicable).

## Notice To Baseplate Installer

### 1. It is YOUR responsibility to watch for:

- Oil cooler and air conditioner lines
- Electrical wires and hoses
- Missing parts or attaching points on the frame

\*\* If the baseplate is improperly installed and is against a wire or hose, it could cause fluid leaks or electrical shorts some time after the actual baseplate installation.

## Permanent Baseplate Safety Cable Installation

Permanent baseplate safety cables are strongly recommended when towing a vehicle with a tow bar. The principle function of the permanent baseplate safety cables is to prevent the towed vehicle from breaking loose in the event the connection between the frame of the towed vehicle and the baseplate fails or becomes disconnected. The cables must be connected from the baseplate to the frame rail or cross member of the vehicle's frame. The illustrations below show the possible arrangements recommended by Blue Ox®. Each permanent baseplate safety cable must have an adequate weight rating for the towing system. The weight rating of the two (2) cables together will not qualify.

***Do not mount the permanent baseplate safety cables against wires, hoses or brake lines.***

These permanent baseplate safety cables should remain installed as long as the baseplate is installed on the vehicle. Permanent baseplate safety cables are to be used in conjunction with, and NOT a replacement for legally required safety cables attaching the towed vehicle to the towing vehicle.

### OPTION #1

Permanent Baseplate Safety Cables to Cross Member or Frame of Towed Vehicle.

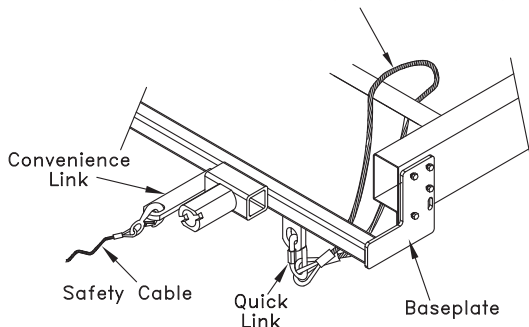

### OPTION #2

Permanent Baseplate Safety Cables to Cross Member or Frame of Towed Vehicle.

