



BX1685

2008-10 Chevy HHR SS (Turbo Only) Installation Instructions

Serial Number

Please read BOTH these Installation Instructions and the General Instructions before attempting to install or operate this equipment.

- Blue Ox® towing products and accessories are intended to be installed by Blue Ox® Dealers who are familiar with our products and have the equipment and knowledge to do “fit work”. When necessary Blue Ox® Dealers can be found at www.blueox.com or by contacting our Customer Care Department at (402) 385-3051.
- Many Blue Ox® Baseplates are designed to use existing holes and hardware to mount the baseplate to the towed vehicle. Even though bolts are there, do not assume they are adequate for baseplate mounting. Always use hardware supplied in the hardware kit or existing hardware specified in the Baseplate Towing Installation Instructions.

Attachment Tab Height: 11”

Attachment Tab Width: 22”

Bolt Torque Specifications
Torque in Foot-Pounds for Metric Bolts

Bolt Size	Grade 8.8	Grade 10.9
6MM	6	8
8MM	16	22
10MM	31	40
12MM	54	70
14MM	89	117

Confirm the towability and pre-towing procedures for your vehicle with the owner’s manual or contact the vehicle’s manufacturer for specific towing procedures.

Bolt Torque Specifications
Torque in Foot-Pounds for Inch Bolts

Bolt Size	Grade 5	Grade 8
1/4”	10	14
5/16”	19	29
3/8”	33	47
7/16”	54	78
1/2”	78	119
5/8”	154	230



If the front of your vehicle looks different than this, call us at (402) 385-3051.

WARNING

Failure to read and follow these instructions could result in separation of the towed vehicle from the tow bar, causing property damage, loss of towed vehicle, personal injury or death.

BX1685

2008-10 Chevy HHR SS (Turbo Only)

Installation Instructions

Parts List

Ref. No.	Qty.	Part #	Description
1	1	61-6637	WLDM'T, BP, BX1685
2	1	101-7400	BRACKET, TURBO, DS, BX1685
3	1	101-7401	BRACKET, TURBO, PS, BX1685
4	8	61-5208	WLD, NUT PLT, 1/4X1X1, 3/8"/14"WIRE
5	8	201-0368	3/8-16 X 1 1/4 HEX HEAD BOLT,GRD. 5
6	8	203-0010	3/8 LOCK WASHER, ZP
7	2	201-0979	#12-14 x 1" Self Drilling Screw, ZP
8	2	201-0192	10-32 X 1/2 SLOT, RD. HD. SCREW
9	2	203-0054	#10 LOCK WASHER
10	2	202-0047	#10-32 HEX NUT
11	2	101-5822	ADAPTER, 4 WAY CONNECTOR
12	2	62-3468	ATT TAB ASSY, REM, SF/SB, 1 HOLE
	2	226-0046	BASEPLATE SAFETY CABLE,36"CLIII(NS)
	4	229-0359	QUICKLINK, 3/8, ZP (Not Shown)
	2	290-0437	RECEIVER, CAP PLUG (BLK) (Not Shown)

Tools

7MM Sock
 10MM Sock
 9/16" Sock
 5/8" Wrenc
 3/8" Nut Dri
 Lg. Vise Gr
 Reciprocati
 Saw

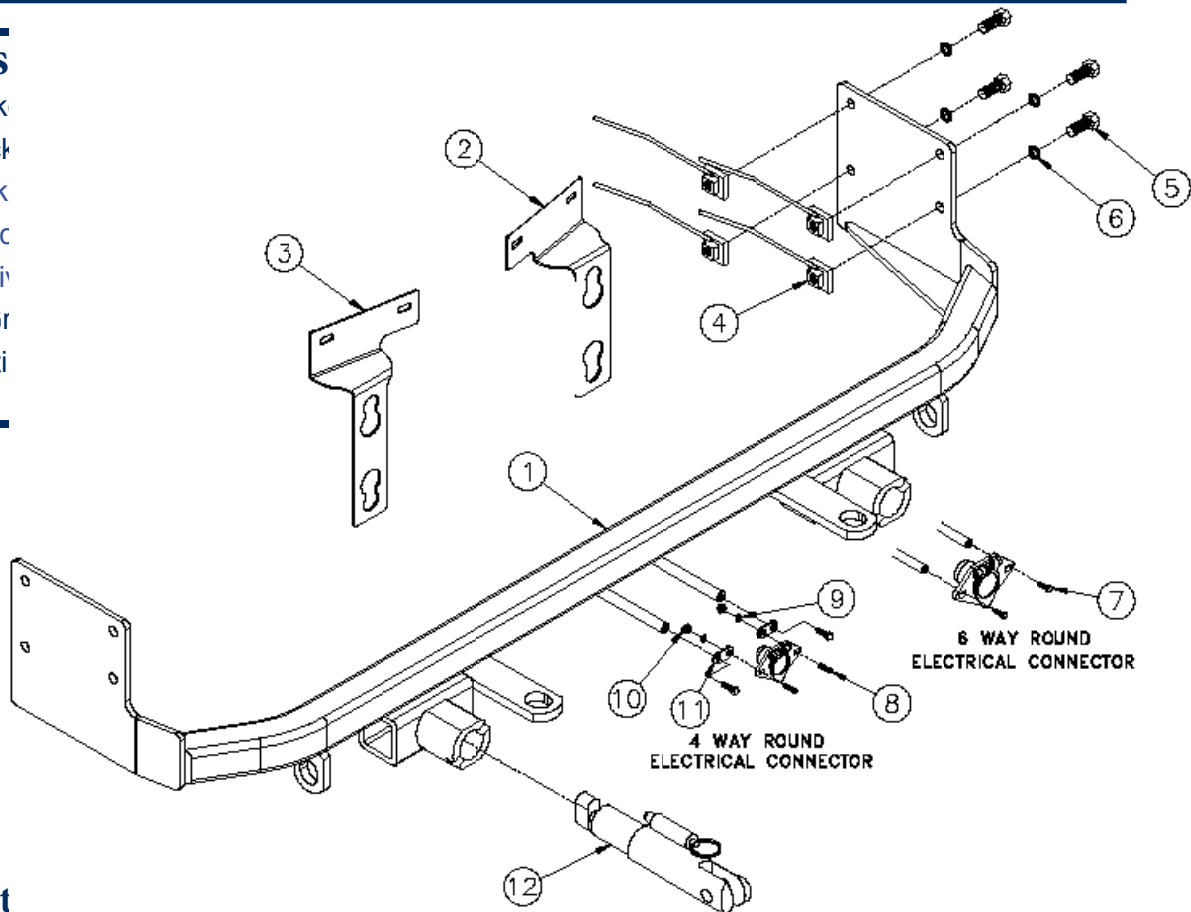

Import

Use only genuine factory replacement parts on your baseplate. Do **NOT** substitute homemade or non-typical parts. If a bolt is lost or in need of replacement, for your safety and the preservation of your baseplate, be sure to use a replacement bolt of the same grade (In most cases it will be Grade 5, please reference the parts list above). Replacement parts may be ordered through your nearest Blue Ox® Dealer or Distributor. Failing to follow and/or altering these installation instructions in either installation or required equipment will void the manufacturer's warranty. Towing behind a non-motorized vehicle will void the warranty.

BX1685
2008-10 Chevy HHR SS (Turbo Only)
Installation Instructions

Attachment Tabs:

Motorhome mount tow bars are recommended for use with this baseplate. Due to the design of the removable tabs, the RangeFinder II, Adventurer, and Ambassador tow bars can not be used. The Acclaim tow bar may be used, but will not fold and store on the front of the vehicle. Adapters, except the BX8833 and BX88151, can not be used with this baseplate.

Instructions:

The front fascia is removed for the baseplate installation. Drilling is required. Trimming of the fascia is required.

The dimensional variations between otherwise identical vehicles can be considerable. While the baseplate was designed for easy installation, it may be necessary to tailor the baseplate slightly to compensate for auto manufacturer's tolerances. These minor adjustments may include filing a hole slightly, bending electrical rods or bending end plates.

The BX8848 4-Diode Wiring Kit is recommended for this vehicle.

Handling of some cosmetic parts when installing this product may require the use of protective covers, rags, specialty tools, etc. to prevent damage.

Installation Instructions:

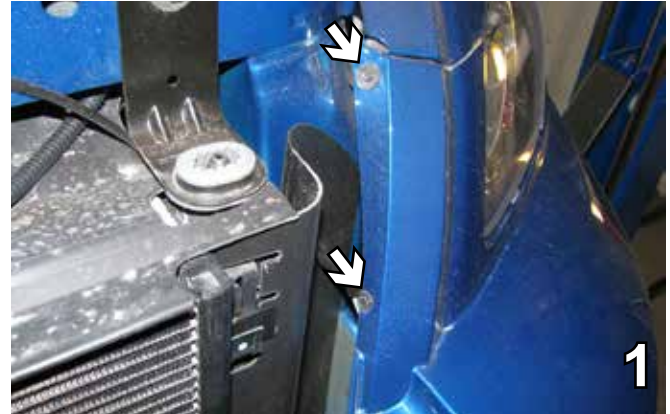

1. Using the 7MM socket remove two 7MM bolts from the front fascia near the headlight housing. This will need to be done to both sides of the vehicle, the driver's side is shown. Set bolts aside to be reinstalled later.

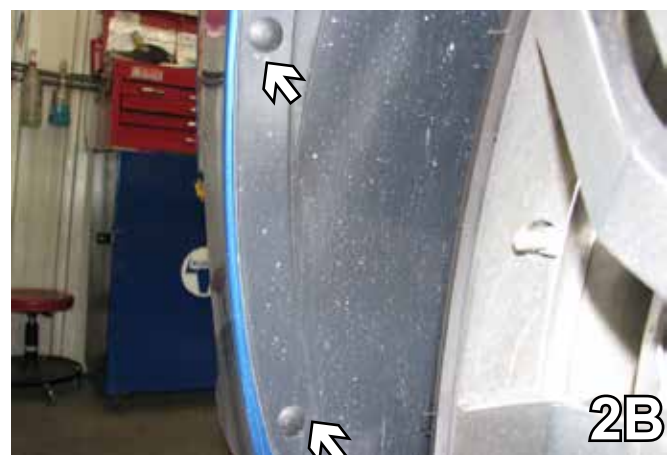

2. Just forward of the front tire, remove one 7MM bolt with the 7MM socket (see grey arrow) and remove two push pins (see white arrows). This is done on both sides of the vehicle, the driver's side is shown. Set all aside to be reinstalled later.

BX1685
2008-10 Chevy HHR SS (Turbo Only)
Installation Instructions



3. Just forward of the front tires, on the under side of the front fascia, remove two push pins. This is done on both sides of the vehicle, the driver's side is shown. Set the push pins aside to be reinstalled later. Pull fascia forward and set aside carefully to be reinstalled later.

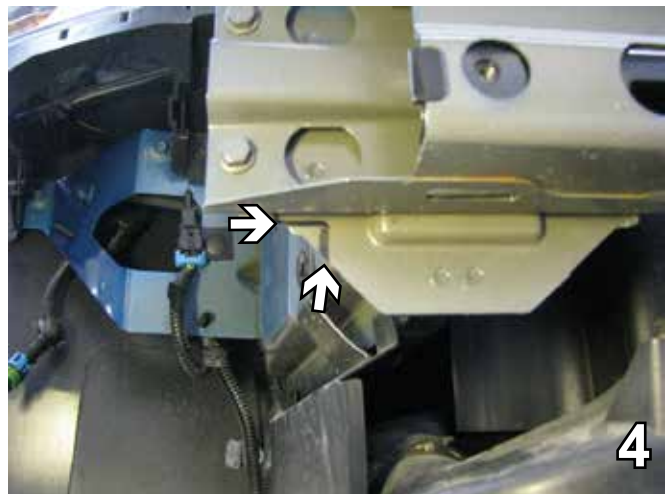

4. Underneath the bumper cut a notch across the bottom and flush with the side. This will need to be done on both sides of the vehicle, the passenger's side is shown.

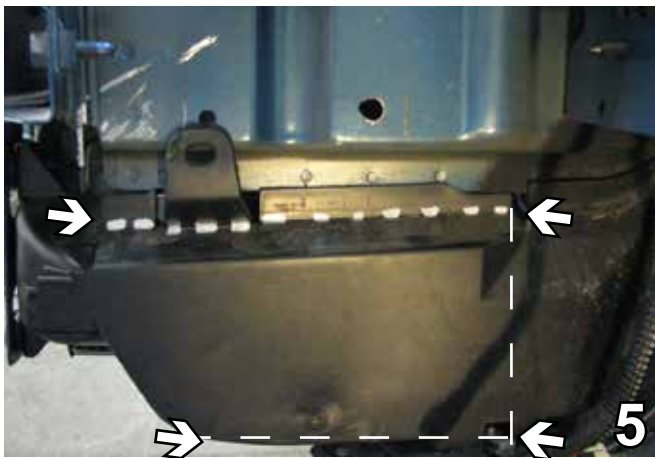

5. Trim the guard horizontally from the edge to the opening on the top and the bottom. Continue trimming connecting the openings vertically. Do this to both sides of the vehicle, the driver's side is shown..

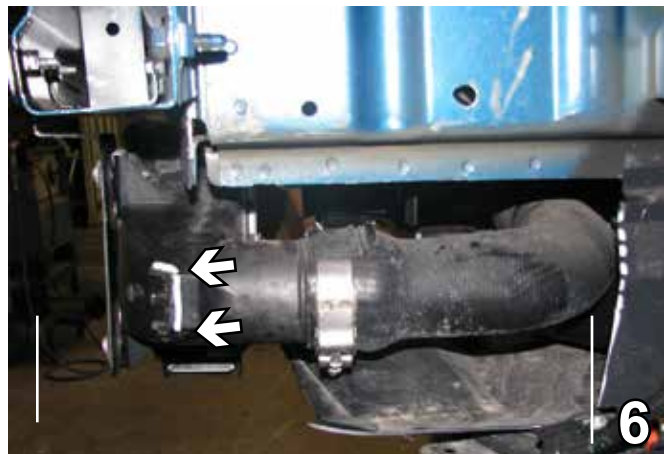

6. Trim the notch off the end of the tube but be careful not to touch anything else. This is done on both sides of the vehicle, the driver's side is shown,

7. Underneath the bumper, trim 2" horizontally from the right edge and 7/8" down. This is done on both sides of the vehicle, the driver's side is shown.

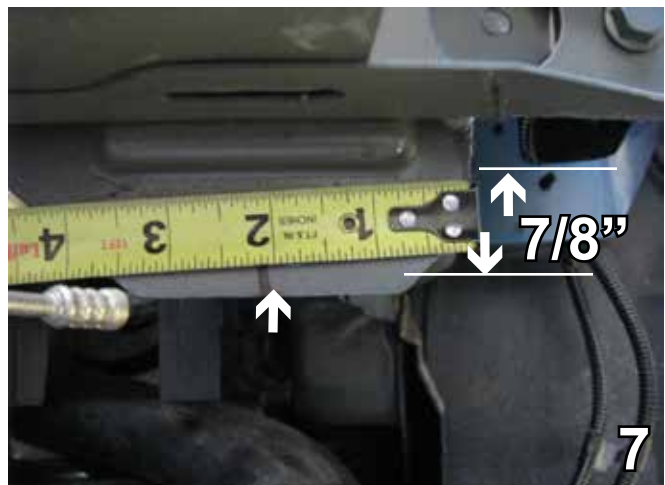

BX1685
2008-10 Chevy HHR SS (Turbo Only)
Installation Instructions



8. Using a vise grip, bend up where we just cut and continue to bend back to the middle of the rib. This is done on both sides of the vehicle.

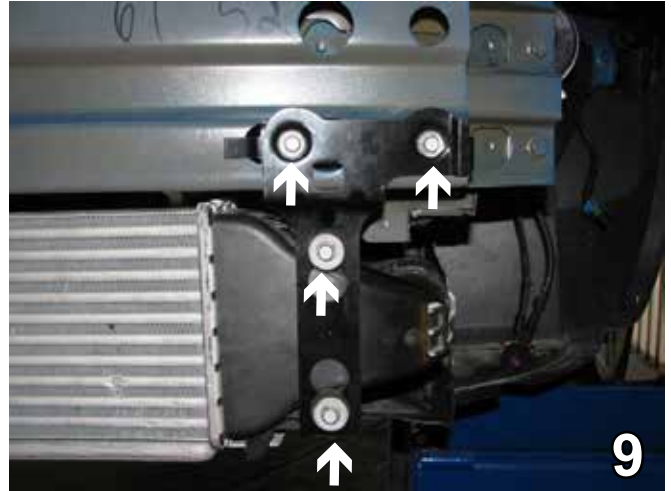

9. This bracket needs to be replaced. Using a 10MM socket, remove the four bolts holding the bracket. This is done on both sides of the vehicle. Set the bolts aside to be used later in reinstalling the new bracket.

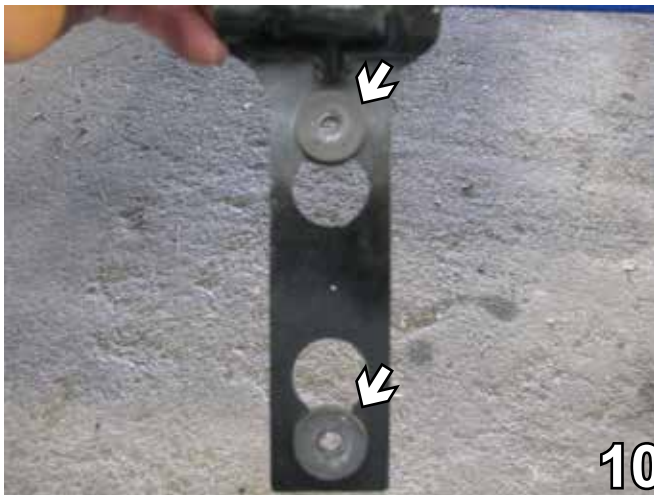

10. Remove the two grommets from each bracket, they will be used with the new bracket.



11. With the turbo hanging down, install the new bracket with the existing bolts, starting with the bottom two and tighten. This is done on both sides of the vehicle.



12. Slide the baseplate up underneath the front edge of the turbo. This is done on both sides of the vehicle.

BX1685
2008-10 Chevy HHR SS (Turbo Only)
Installation Instructions



13. Continue to move the baseplate and the turbo on up into position. This is done on both sides of the vehicle.



14. Align the baseplate with the existing hole. Clamp across the top of the frame with the large vise grip. This is done on both sides of the vehicle.

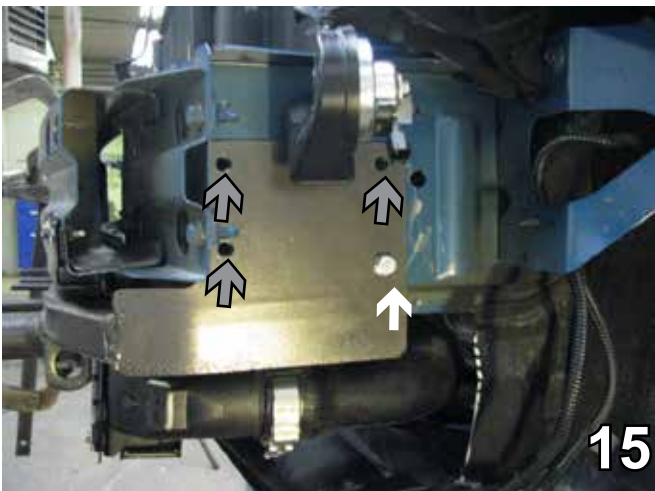

15. Insert a 3/8-16 x 1 1/4" hex bolt with 3/8" lock washer into the existing hole (white arrow). Be sure to use Loctite. Attach it to a 3/8-16 nut plate. Using the baseplate as a template, drill the three remaining holes (gray arrows) with a 13/32" drill bit. This is done on both sides of the vehicle.



16. Insert three more 3/8-16 x 1 1/4" hex bolts with 3/8" lock washers and attach to 3/8-16 nut plates. Be sure to use Loctite. This is done on both sides of the vehicle.

BE SURE TO USE LOCTITE® RED ON ALL BOLTS BEFORE TIGHTENING. TIGHTEN ALL BOLTS ACCORDING TO THE TORQUE CHART ON THE FRONT PAGE OF THESE INSTRUCTIONS OR ON PAGE 3 OF THE BASEPLATE GENERAL TOWING INSTRUCTIONS.

BX1685
2008-10 Chevy HHR SS (Turbo Only)
Installation Instructions



17. Cut the excess wire from the nut plates once they are installed. This is done on both sides of the vehicle.



18. Attach permanent baseplate safety cables to the quick link on the baseplate. On the driver's side, the cables go straight back and around the frame of vehicle. Additional options may interfere with suggested mounting, in this case secure the cables to a solid piece of the frame as described in instructions included with the permanent baseplate safety cables. Be sure the safety cables do not rub against any hoses or moving parts.



19. Attach the permanent baseplate safety cables to the provided convenience link on the baseplate (see grey arrow). The photo above shows the recommended installation of the cables to frame of vehicle on the passenger side (see white arrow). Additional options may interfere with suggested mounting; in this case secure the cables to a solid piece of the frame as described in the instructions included with the permanent baseplate safety cables. Be sure the safety cables do not rub against any hoses or moving parts. Do this to both sides of the vehicle.



20. On the back side of the fascia, use a utility knife to cut the tall tab off. This is done on both sides of the vehicle. Reinstall the front fascia.

Be sure that ALL electrical connections are plugged in properly and functioning BEFORE installing the fascia.

BX1685
2008-10 Chevy HHR SS (Turbo Only)
Installation Instructions



DEALER or INSTALLER:
Be certain the user receives the
instruction sheets for their products.

CUSTOMER SERVICE COMMITMENT

Blue Ox is committed to providing you with exceptional customer care throughout your lifetime with our products. Our team is here to assist you with any questions you may have regarding the performance of your product. Simply call (402) 385-3051 and you can speak with our customer care team.

Additionally, please visit our website to see which rallies our Destination America team will be attending. For a nominal fee, our service technician will service your towing system to ensure it's in proper working condition. Also as a commitment to our customers, should you visit our factory you can stay at our full service Blue Ox campground at no charge along with enjoying a factory tour.

Again thank you for being our customer and for the confidence you have shown in the performance of our products. It is because of customers like you we enjoy the success we have today.

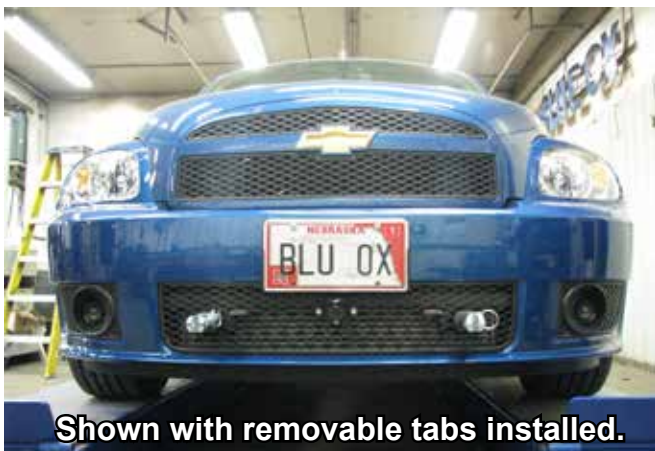

If the baseplate is in an accident, it must be replaced. DO NOT use it again! An accident can cause unseen damage and using it again could result in more damage or serious injury. DO NOT use the baseplate if it is damaged or missing parts.



© 2009, 10 Blue Ox
One Mill Road, Industrial Park
Pender, Nebraska 68047
Phone: (402) 385-3051
Fax: (402) 385-3360
www.blueox.com

General Information

1. Ensure that your product(s) are registered online at www.blueox.com. It is crucial to register your product(s) so that you may be alerted of product offerings, updates, upgrades, maintenance and safety bulletins, and/or recalls.
2. **It is the owner's responsibility to inspect all towing equipment for cracked welds, missing or worn parts and loose bolts before each towing trip.** Be sure to use Loctite® Red on all bolts and tighten to the recommended specifications.
3. **It is the owner's responsibility to hook up all towing equipment per manufacturer's instructions/recommendations.**
4. Remove the attachment tabs when not in use (if applicable).

Notice To Baseplate Installer

1. It is YOUR responsibility to watch for:

- Oil cooler and air conditioner lines
- Electrical wires and hoses
- Missing parts or attaching points on the frame

** If the baseplate is improperly installed and is against a wire or hose, it could cause fluid leaks or electrical shorts some time after the actual baseplate installation.

Permanent Baseplate Safety Cable Installation

Permanent baseplate safety cables are strongly recommended when towing a vehicle with a tow bar. The principle function of the permanent baseplate safety cables is to prevent the towed vehicle from breaking loose in the event the connection between the frame of the towed vehicle and the baseplate fails or becomes disconnected. The cables must be connected from the baseplate to the frame rail or cross member of the vehicle's frame. The illustrations below show the possible arrangements recommended by Blue Ox®. Each permanent baseplate safety cable must have an adequate weight rating for the towing system. The weight rating of the two (2) cables together will not qualify.

Do not mount the permanent baseplate safety cables against wires, hoses or brake lines.

These permanent baseplate safety cables should remain installed as long as the baseplate is installed on the vehicle. Permanent baseplate safety cables are to be used in conjunction with, and NOT a replacement for legally required safety cables attaching the towed vehicle to the towing vehicle.

OPTION #1

Permanent Baseplate Safety Cables to Cross Member or Frame of Towed Vehicle.



OPTION #2

Permanent Baseplate Safety Cables to Cross Member or Frame of Towed Vehicle.

