



Baseplate Installation Instructions

BX1306 2009 BMW Mini Cooper (Manual Transmission Only) (No S) Installation Instructions

Serial Number

Please read BOTH these Installation Instructions and the General Towing Instructions before attempting to install or operate this equipment.

1. Blue Ox® towing products and accessories are intended to be installed by Blue Ox® Dealers who are familiar with our products and have the equipment and knowledge to do “fit work.” When necessary, Blue Ox® Dealers can be found at www.blueox.com or by contacting our Customer Care Department at (402) 385-3051.

Attachment Tab Height: 12”
Attachment Tab Width: 22”

2. Many Blue Ox® Baseplates are designed to use existing holes and hardware to mount the baseplate to the towed vehicle. Even though bolts are there, do not assume they are adequate for baseplate mounting. Always use hardware supplied in the hardware kit or existing hardware specified in the Baseplate Towing Installation Instructions.

Bolt Torque Specifications
Torque in Foot-Pounds for Metric Bolts

Bolt Size	Grade 8.8	Grade 10.9
6MM	6	8
8MM	16	22
10MM	31	40
12MM	54	70
14MM	89	117

Confirm the towability and pre-towing procedures for your vehicle with the owner’s manual or contact the vehicle’s manufacturer for specific towing procedures.

Bolt Torque Specifications
Torque in Foot-Pounds for Inch Bolts

Bolt Size	Grade 5	Grade 8
1/4”	10	14
5/16”	19	29
3/8”	33	47
7/16”	54	78
1/2”	78	119
5/8”	154	230

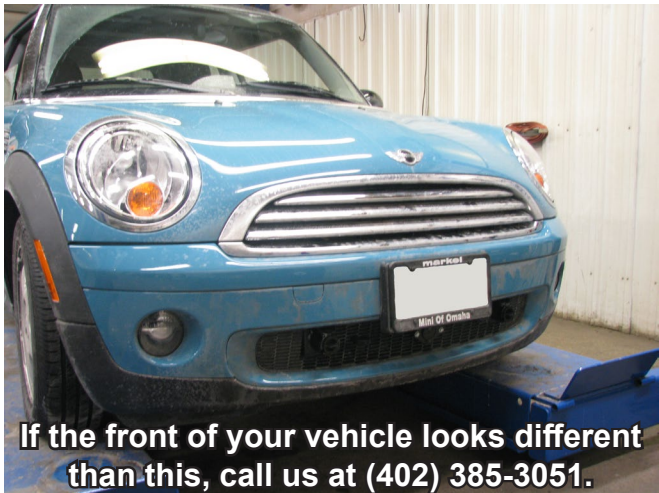

If the front of your vehicle looks different than this, call us at (402) 385-3051.

! WARNING
Failure to read and follow these instructions could result in separation of the towed vehicle from the tow bar, causing property damage, loss of towed vehicle, personal injury or death.

BX1306
2009 BMW Mini Cooper
 (Manual Transmission Only) (No S)
 Installation Instructions

Parts List

Ref. No.	Qty.	Part #	Description
1	1	61-6607	Weldment, Baseplate, BX1306
2	6	61-5208	Weldment, Nut Plate, 1/4 x 1 x 1, 3/8"
3	6	201-0368	3/8-16 x 1 1/4" Hex Head Bolt, Grd. 5, ZP
4	8	203-0010	3/8" Lock Washer, ZP
5	4	203-0003	3/8" Flat Washer, ZP
6	2	201-0419	8MM-1.25 x 50MM Hex Bolt, Grd. 8.8, ZP
7	2	201-0979	#12-14 x 1" Self Drilling Screw, ZP
8	2	201-0192	#10-32 x 1/2" Slot, Round Head Screw
9	2	203-0054	#10 Lock Washer
10	2	202-0047	#10-32 Hex Nut
11	2	101-5822	Adapter, 4 Way Connector
12	2	62-3468	Attachment, Assembly, SF/SB, 1 Hole
13	2	102-6816	Backing Plate, BX1304
	2	226-0046	Baseplate Safety Cable, 36" Class III (Not Shown)
	4	229-0359	Quicklink, 3/8", ZP (Not Shown)
	2	290-0437	Cap Plug, Black (Not Shown)

Tools Required

10MM Socket
 13MM Socket/Wrench
 9/16" Socket/Wrench
 T25 Torx
 Large Vise Grip
 Flat Screwdriver
 Phillips Screwdriver
 Utility Knife
 Drill
 1 1/4" Hole Saw
 13/32" Drill Bit
 Loctite RED

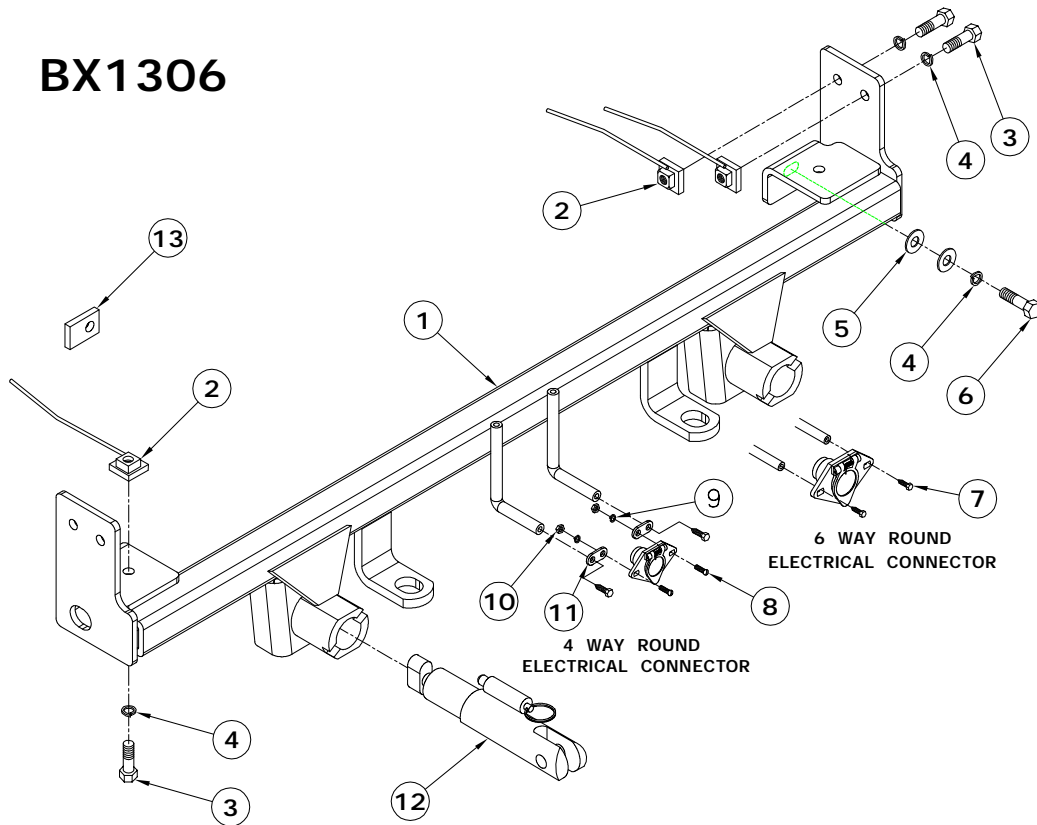

Important:

Use only genuine factory replacement parts on your baseplate. Do **NOT** substitute homemade or non-typical parts. If a bolt is lost or in need of replacement, for your safety and the preservation of your baseplate, be sure to use a replacement bolt of the same grade (In most cases it will be Grade 5, please reference the parts list above). Replacement parts may be ordered through your nearest Blue Ox® Dealer or Distributor. Failing to follow and/or altering these installation instructions in either installation or required equipment will void the manufacturer's warranty. Towing behind a non-motorized vehicle will void the warranty.

BX1306

2009 BMW Mini Cooper (Manual Transmission Only) (No S)

Installation Instructions

Vehicle Weight:

Motorhome mount tow bars are recommended for use with this baseplate. Due to the design of the removable tabs, the RangeFinderII, Adventurer, and Ambassador tow bars can not be used. The Acclaim tow bar may be used, but will not fold and store on the front of the vehicle. Adapters, except the BX8833 and BX88151, can not be used with this baseplate.

Installation Notes: The grill, fascia and temperature sensor are removed and reinstalled during installation of the baseplate. Drilling is required. Trimming of the fascia is required.

The dimensional variations between otherwise identical vehicles can be considerable. While the baseplate was designed for easy installation, it may be necessary to tailor the baseplate slightly to compensate for auto manufacturer's tolerances. These minor adjustments may include filing a hole slightly, bending electrical rods or bending end plates.

The BX8848 Diode Wiring Kit is recommended for this vehicle.

Handling of some cosmetic parts when installing this product may require the use of protective covers, rags, specialty tools, etc. to prevent damage.

Installation Instructions:

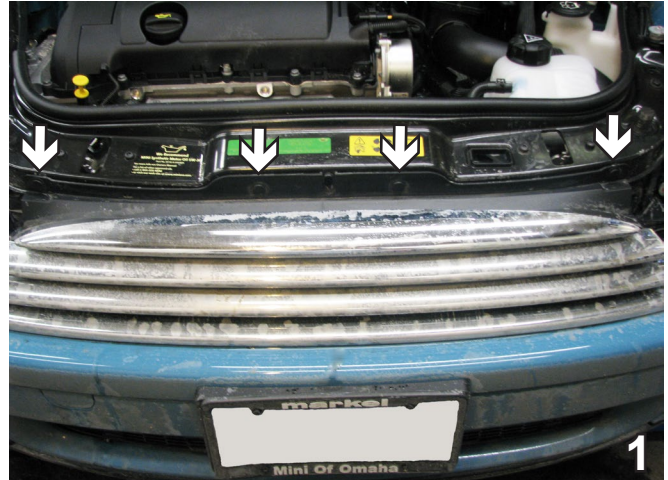

1. Using a flat screwdriver, remove four (4) push pins on top edge of grill, one (1) on each side two in the middle. Set push pins aside to be reinstalled later.



2. Forward the front tire, use a Phillips screwdriver to remove two (2) push pins. Do this to both sides. Set aside for later reinstallation.

BX1306
2009 BMW Mini Cooper
(Manual Transmission Only) (No S)
Installation Instructions

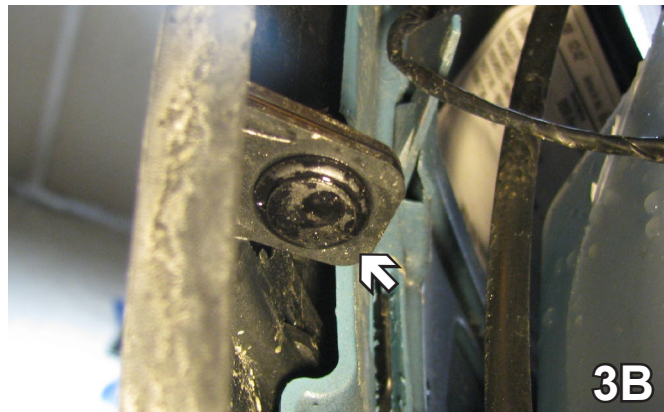
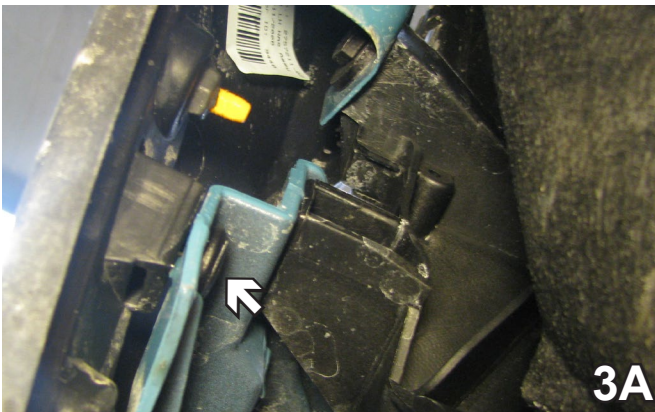

3. After removing the wheel well cover, remove two (2) push pins connecting the fascia using a flat screwdriver. Do this to both sides. Set push pins aside for later reinstallation.

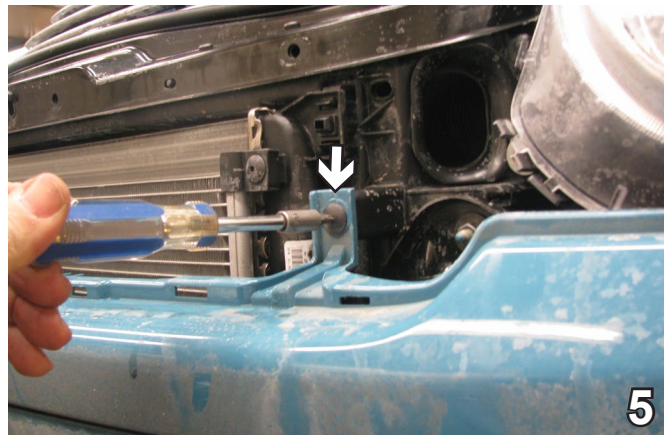

4. Remove the grill by starting from the side and working across. Use a screwdriver to pry and release the clips. They will fit back in when reinstallation occurs. Set the grill aside for later reinstallation.

5. After removing the grill, by the headlight, there is a bolt that needs to be removed with a T25 torx. Do this on both sides. Set bolts aside for later reinstallation.

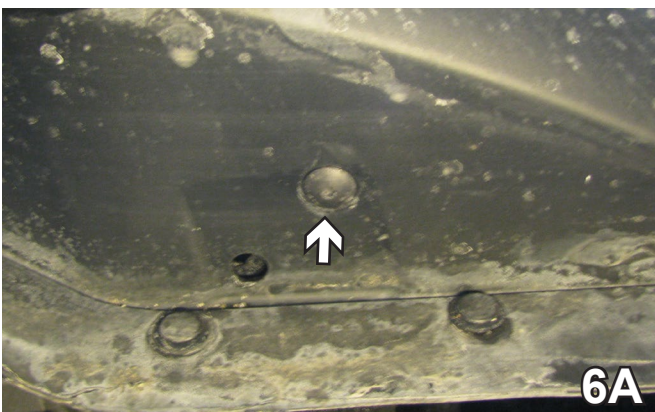

5. There is also a torx 25T bolt (photo 6A) to be removed from both sides using a torx wrench. Remove the three (3) push pins in the center (photo 6B). Pull the fascia forward, disconnect side running and fog lights. Set aside carefully for later reinstallation.

BX1306
2009 BMW Mini Cooper
(Manual Transmission Only) (No S)
Installation Instructions

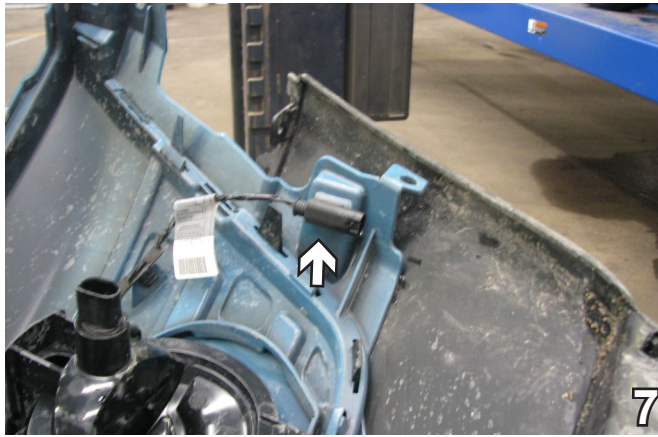

7. Located on both sides behind the grill, there is a temperature sensor that will need to be unplugged.

Using a good quality paint, spray cut edges of frame to prevent rusting.

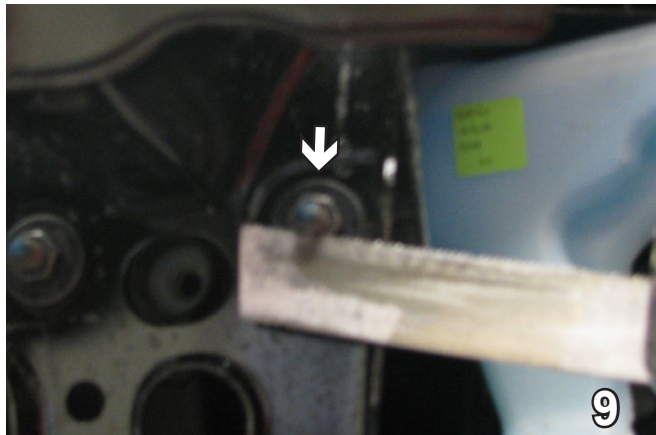

9. Use the reciprocating saw to cut off the bolt even with the nut. Do this on both sides.

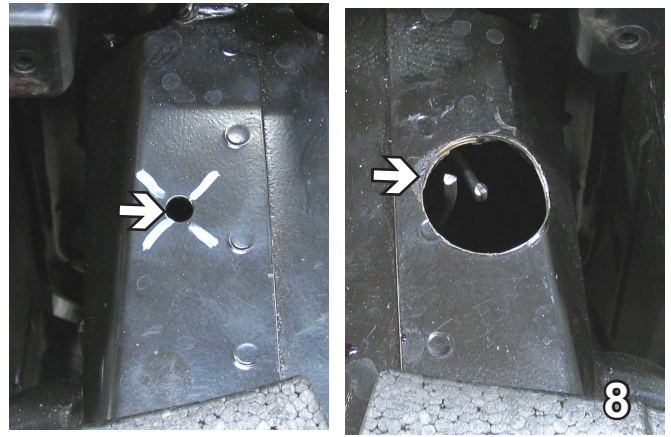
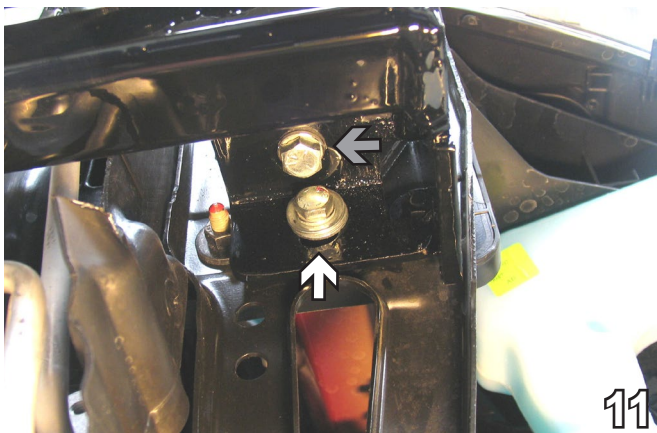

8. Using an existing hole on top of the metal bumper drill a hole using a 1 1/4" hole saw to cut opening for front end to install nut plates. Do this on both sides.

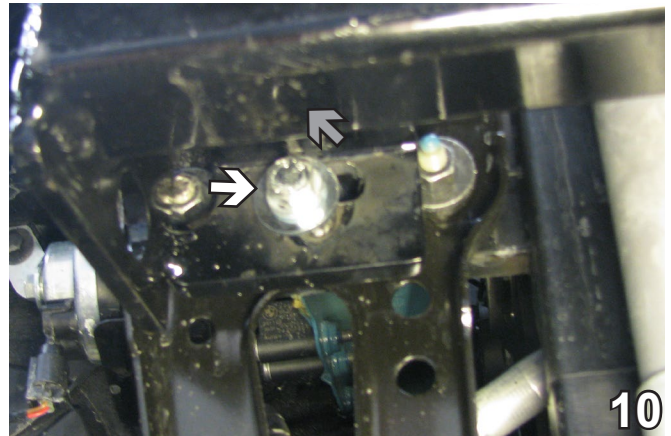

10. Hold the baseplate up in place and start the 8MM-1.25 x 50MM hex bolt (white arrow) with lock and two flat washers into existing hole, make it snug. Using the baseplate as a template, drill the hole above (gray arrow). Do this to both sides using a 13/32" drill bit.

BE SURE TO USE LOCTITE® RED ON ALL BOLTS BEFORE TIGHTENING. TIGHTEN ALL BOLTS ACCORDING TO THE TORQUE CHART ON THE FRONT PAGE OF THESE INSTRUCTIONS OR ON PAGE 3 OF THE BASEPLATE TOWING GENERAL INSTRUCTIONS.

11. Remove the metric bolt (white arrow), replace bolt and washers with Loctite applied. Insert into the top hole (gray arrow) 3/8-16 x 1 1/4' bolt with Loctite, 3/8" lock washer and tighten to 3/8-16 nut plate. Then tighten the metric bolt. Do this on both sides.

BX1306
2009 BMW Mini Cooper
(Manual Transmission Only) (No S)
Installation Instructions



12. Using the baseplate as a template, drill two (2) holes on the side. Do this on both sides using a 13/32" drill bit.



13. Into the holes drilled in the side also insert 3/8-16 x 1 1/4" bolts with Loctite, 3/8" lock washers and 3/8" nut plates. Do this on both sides.

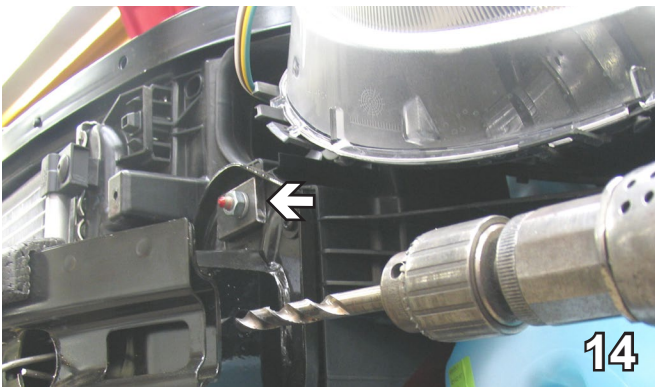

14. Using the 13MM socket, remove top hex nut from bumper extension and install item #13 between frame end and hex nut.

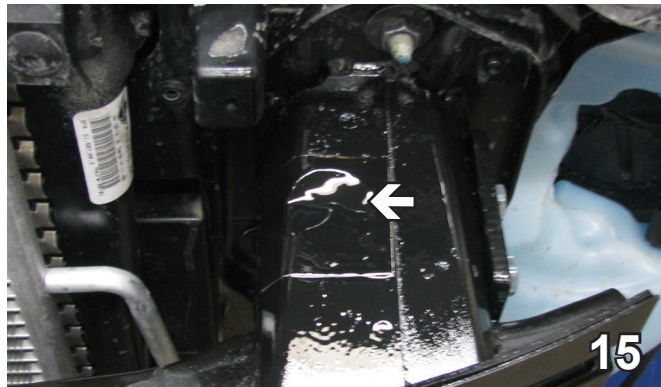

15. Cover the 1 1/4" hole used to install the nut plates with tape and paint black. Do this on both sides.

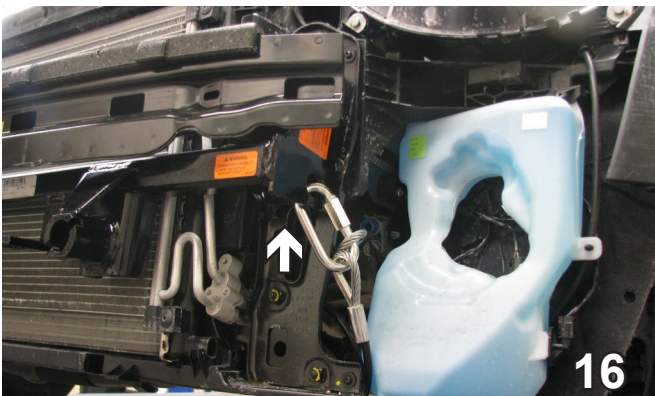

16. The photo above shows recommended installation of the cables to frame of vehicle. If vehicle has additional options (not shown above) which interfere with mounting permanent baseplate safety cables, secure the cables to a solid piece of the vehicle frame as described in instructions included with the permanent baseplate safety cables.

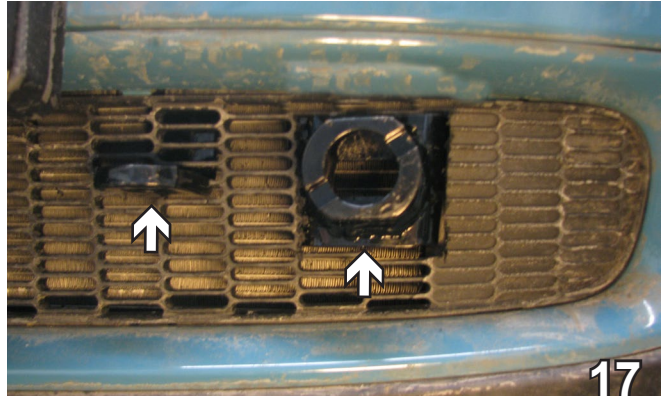

17. Reconnect the temperature sensor. Hold the fascia up to its original location. Mark and trim the fascia just on the outside edges of the receiver tube and convenience links. Do this to both sides of the vehicle. Reinstall the grill.

BX1306

2009 BMW Mini Cooper

(Manual Transmission Only) (No S)

Installation Instructions

Be sure that **ALL** electrical connections are plugged in properly and functioning **BEFORE** installing the fascia.

DEALER or INSTALLER:
Be certain the user receives the instruction sheets for their products.



If the baseplate is in an accident, it must be replaced. **DO NOT** use it again! An accident can cause unseen damage and using it again could result in more damage or serious injury. **DO NOT** use the baseplate if it is damaged or missing parts.

CUSTOMER SERVICE COMMITMENT

Blue Ox is committed to providing you with exceptional customer care throughout your lifetime with our products. Our team is here to assist you with any questions you may have regarding the performance of your product. Simply call 1-800-228-9289 and you can speak with our customer care team.

Additionally, please visit our website to see which rallies our Destination America team will be attending. For a nominal fee, our service technician will service your towing system to ensure it's in proper working condition. Also as a commitment to our customers, should you visit our factory you can stay at our full service Blue Ox campground at no charge along with enjoying a factory tour.

Again thank you for being our customer and for the confidence you have shown in the performance of our products. It is because of customers like you we enjoy the success we have today.



© 2009, 10 Blue Ox
One Mill Road, Industrial Park
Pender, Nebraska 68047
Phone: (402) 385-3051 • Fax: (402) 385-3360
www.blueox.com

General Information

1. Ensure that your product(s) are registered online at www.blueox.com. It is crucial to register your product(s) so that you may be alerted of product offerings, updates, upgrades, maintenance and safety bulletins, and/or recalls.
2. **It is the owner's responsibility to inspect all towing equipment for cracked welds, missing or worn parts and loose bolts before each towing trip.** Be sure to use Loctite® Red on all bolts and tighten to the recommended specifications.
3. **It is the owner's responsibility to hook up all towing equipment per manufacturer's instructions/recommendations.**
4. Remove the attachment tabs when not in use (if applicable).

Notice To Baseplate Installer

1. It is YOUR responsibility to watch for:

- Oil cooler and air conditioner lines
- Electrical wires and hoses
- Missing parts or attaching points on the frame

** If the baseplate is improperly installed and is against a wire or hose, it could cause fluid leaks or electrical shorts some time after the actual baseplate installation.

Permanent Baseplate Safety Cable Installation

Permanent baseplate safety cables are strongly recommended when towing a vehicle with a tow bar. The principle function of the permanent baseplate safety cables is to prevent the towed vehicle from breaking loose in the event the connection between the frame of the towed vehicle and the baseplate fails or becomes disconnected. The cables must be connected from the baseplate to the frame rail or cross member of the vehicle's frame. The illustrations below show the possible arrangements recommended by Blue Ox®. Each permanent baseplate safety cable must have an adequate weight rating for the towing system. The weight rating of the two (2) cables together will not qualify.

Do not mount the permanent baseplate safety cables against wires, hoses or brake lines.

These permanent baseplate safety cables should remain installed as long as the baseplate is installed on the vehicle. Permanent baseplate safety cables are to be used in conjunction with, and NOT a replacement for legally required safety cables attaching the towed vehicle to the towing vehicle.

OPTION #1

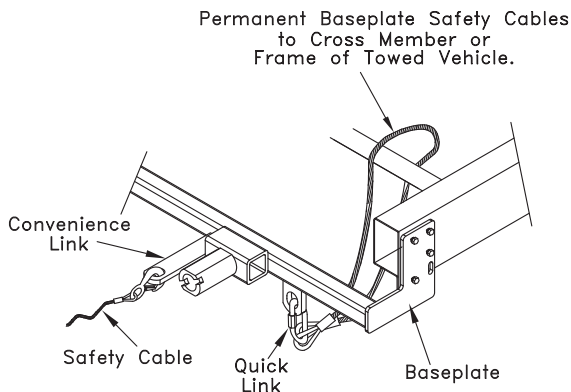

OPTION #2

