



Light Bar / Brush Guard Installation Instructions

P/N 280096: 2019+ Mercedes Sprinter Light Bar

NOTE: THIS PRODUCT IS NOT COMPATIBLE WITH THE SPRINTER 3500 DUALY

Before you begin:

- *Stainless steel hardware may bind together when tightening — apply an anti-seize assembly lubricant to the threads of each bolt before assembly*
- *This installation requires two or more people*
- *Unless otherwise specified, refer to the general torque value at the end of the instructions for specified torque values.*



Required Tools:

- **Standard and metric wrench set**
- **Standard and metric socket set**
- **Phillips head screwdriver**
- **Standard Allen set**

Included Hardware:

<i>P/N</i>	<i>Description</i>	<i>Quantity</i>
70008	¼-20 SS Nylock Nut	2
70009	¼" SS Flat Washer	4
70060	¼-20 x 1" SS Button Head Bolt	2
70446	5/16"-18 x 1-1/4" SS Button Head Bolt, Black Oxide	14
70345	5/16" SS Flat Washer, Black Oxide	28
70346	5/16"-18 SS Nylon Locking Nut, Black Oxide	14
70095	M8-1.25 x 20mm 8.8 Steel Hex Head Bolt	4
70124	M8-1.25 x 40mm Fully Threaded 8.8 Steel Hex Head Bolt	2
70111	5/16" Zinc Plated Split Lock Washer	6
70246	Anti-seize package	1

Additional Parts:

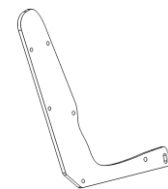
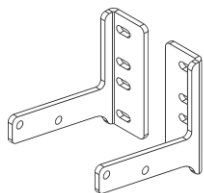



Installation Instructions

1. Assemble your Light Bar from the three (3) individual sections and the two (2) mounting blades using the black 5/16"-18 hardware provided (reference Figure 1 & below Figure 2).

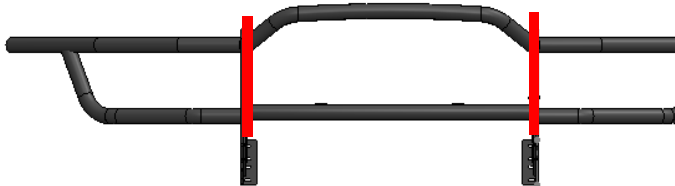

Figure 1: Light Bar Assembled

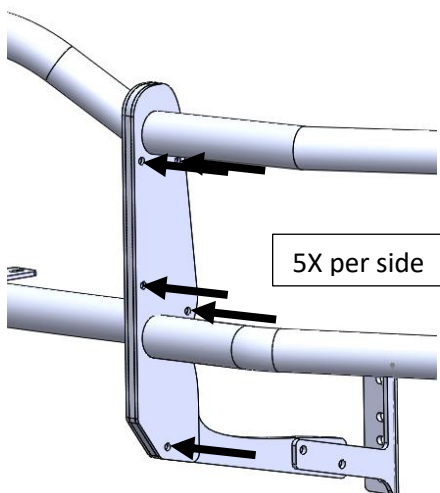
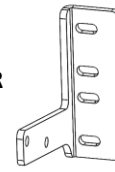

Figure 2: Assembly Hardware Locations

2. Install the Light Bar mounting brackets to the attachment points shown in Figure 3 & Figure 4. There are two sets of slotted holes for 2WD and 4WD; brackets should mount as close to the plastic bumper as possible. Install the mounting brackets on top of the crossmember using the provided M8-1.25 x 20mm bolts and 5/16" split washer in the appropriate slotted holes.

PRO TIP: Remove bolts only from one side at a time, so that the crossmember stays in place during installation.

PASSENGER



DRIVER



Figure 3: Mounting Brackets

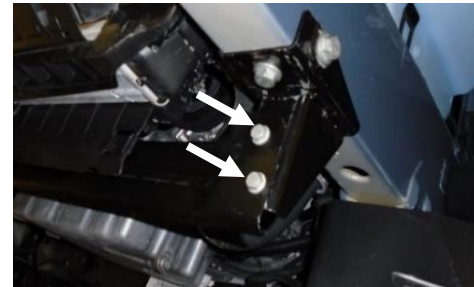

Figure 4: Mounting Location on Vehicle of Mounting Brackets

3. Install aftermarket lights onto Light Bar, if applicable.
4. Install Light Bar onto mounting brackets and bolt down using included 5/16"-18 x 1 1/4" bolts. Reference Figure 5.

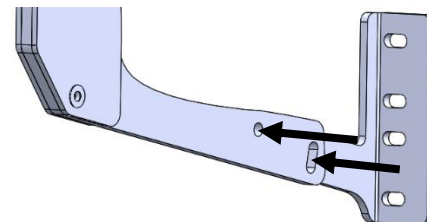

Figure 5: Light Bar Installation onto Brackets

PRO TIP: Only keep mounting bolts hand-tight at first, rotate the light bar into desired position, and then tighten down.

5. Mount both front step straps to the Light Bar using the 1/4"-20 x 1" bolts, washers, and nuts. Then bolt down the light bar to the vehicle using the supplied M8-1.25 x 65mm bolts and 5/16" split washer.
6. If you are installing with a Front Receiver and/or Winch, mount the Light Bar blades to the Front Receiver using the provided right angle straps through the cutouts in your front bumper (see front receiver installation instructions for more detail on this – see Figure 6).

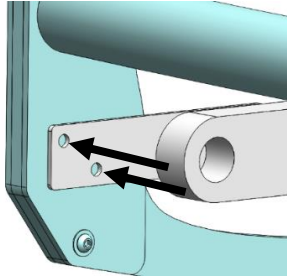

Figure 6: Mounting Straps to Front Receiver with Winch

7. Verify all mounting points are tight and snug, and enjoy your new Aluminess Light Bar!



General Torque Values			
Size	Stainless Steel	Zinc	Grade 8
#6-32	10 lb-ft	--	--
#8-32	18.4 lb-ft	--	--
#10-32	26.6 lb-ft	--	--
1/4"-20	5.3 lb-ft	7.8 lb-ft	9 lb-ft
5/16"-18	10.9 lb-ft	16 lb-ft	18 lb-ft
3/8"-16	19.4 lb-ft	28.3 lb-ft	33 lb-ft
7/16"-14	31 lb-ft	45 lb-ft	52 lb-ft
1/2"-13	47 lb-ft	69 lb-ft	80 lb-ft
M6	4.7 lb-ft	5.8 lb-ft	--
M8	11.3 lb-ft	14.1 lb-ft	--
M10	22.3 lb-ft	27.9 lb-ft	--
M12	38.9 lb-ft	48.7 lb-ft	--



Aluminess Products, Inc. (Aluminess) Warranty

1. Lifetime Warranty. Aluminess provides a lifetime warranty of its products to the original retail purchaser provided such products are installed correctly according to the official Aluminess installation instructions. Any modification to the original product design, function or use of any Aluminess products will void the Aluminess warranty. Aluminess will have sole discretion to determine warranty eligibility for any and all Aluminess products sold to any purchaser.
2. Limited Remedies. Subject to any limitations and exclusions described herein, and subject to Aluminess' determination of warranty eligibility, Aluminess will remedy defects in product materials and/or workmanship of any product by repairing or replacing such defective product, which shall be within Aluminess' sole discretion, without charge for parts or labor. Aluminess may elect in its sole discretion not to replace a defective product and issue the purchaser a refund equal to the purchase price of any defective product or purchaser may elect to receive a credit (equal to such refund) toward the purchase of new Aluminess products. Repair or replacement of a defective product or providing a refund or credit to purchaser will be purchaser's exclusive remedy under this warranty. Damage to a purchaser's vehicle, cargo and/or any other person or property is expressly excluded from the Aluminess warranty.
3. Modification. Aluminess products are designed to be mounted to factory equipped vehicles. Aftermarket additions to such vehicle may or may not require modification of an Aluminess product. The Aluminess warranty does not extend to any Aluminess products that are modified to fit around other otherwise accommodate or be compatible with any aftermarket vehicle accessories or alterations. Aluminess does not guarantee fitment with any other aftermarket accessories or modified vehicle, and it is up to purchaser to determine fitment prior to purchasing any Aluminess product.
4. Damage. Damage to Aluminess products due to normal wear and tear, including, but not limited to, cosmetic issues and superficial scratches, or structural damage to an Aluminess product in connection with any vehicle collisions or other structural degradation in connection with the use of such vehicle (on road or off road) will not be covered by the Aluminess warranty. Additionally, any product user's misuse, neglect, overloading, improper maintenance or improper installation or repair of any Aluminess products are not covered under the Aluminess warranty.
5. Use of the Products. Aluminess products are designed for off road vehicle use. Installing Aluminess products on a vehicle may exceed the factory designed capabilities of such vehicle and could potentially lead to vehicle damage. Aluminess will not be responsible for any damage caused to a purchaser or user's vehicle or any vehicle accessories caused by the use of any Aluminess products. It is to the sole responsibility of purchaser to inspect and ensure that the intended vehicle and Aluminess products are suitable and compatible for travel on road and off road. No seller nor any manufacturer of Aluminess products will be liable for any loss, damage or injury directly or indirectly arising from the use of any Aluminess products. Before using any Aluminess products, the purchaser or user will determine the suitability of the product(s) for their intended use(s) and the purchaser or user shall assume all responsibility and risk in connection therewith.
6. DISCLAIMER. THE ALUMINESS WARRANTY IS EXPRESSLY MADE IN LIEU OF ANY AND ALL OTHER WARRANTIES, AND EXCEPT FOR THE ALUMINESS WARRANTY SET FORTH HEREIN, ALUMINESS MAKES NO WARRANTY WHATSOEVER WITH RESPECT TO ANY ALUMINESS PRODUCT, INCLUDING ANY WARRANTY OF MERCHANTABILITY AND FITNESS FOR A PARTICULAR PURPOSE, WHETHER EXPRESS OR IMPLIED BY LAW, COURSE OF DEALING, COURSE OF PERFORMANCE, USAGE OF TRADE, OR OTHERWISE.

EXCEPT FOR PURCHASER'S LIMITED REMEDIES SET FORTH HEREIN, IN NO EVENT WILL ALUMINESS BE LIABLE FOR ANY LOST PROFITS, LOST SALES, OR FOR ANY CONSEQUENTIAL, DIRECT, INDIRECT, INCIDENTAL, SPECIAL, EXEMPLARY OR PUNITIVE DAMAGES OR FOR ANY OTHER DAMAGES OF ANY KIND OR NATURE.
7. Compliance. Aluminess cannot guarantee that its products comply with all Federal, State, and/or local laws. Purchaser is advised to review local vehicle codes for compatibility prior to purchase to ensure that the installation and use of any Aluminess products does not violate any applicable laws.
8. Warranty Claim Submission. Purchaser will responsible for returning any defective product to Aluminess for warranty consideration and purchaser may be responsible for all costs associated with shipping the product to and from Aluminess. Prior to returning any product for warranty, purchaser must contact Aluminess Products Inc. for proper authorization.