



***baja designs***<sup>®</sup>  
THE SCIENTISTS OF LIGHTING

**Toyota 22+Tundra/ 24+Tacoma S2 OEM Fog Light  
Replacement Kit  
44-8080, 44-8162, 44-8167, 44-8081**



2950 Norman Strasse • San Marcos • CA • 92069

Phone 760-560-2252 X3 • Fax 760-560-0383

info@bajadesigns.com • [www.bajadesigns.com](http://www.bajadesigns.com)



***baja designs***<sup>®</sup>  
THE SCIENTISTS OF LIGHTING

## LIMITED LIFETIME WARRANTY

Baja Designs proudly offers a LIFETIME WARRANTY against manufacturer's defect on all the products that we manufacture.

These are comprehensive warranties; other than the exclusions below – you're covered. If your LED or HID bulb burns out, you're covered. Additionally, cutting off our connector or changing your lenses does not automatically void your warranty.

### **Exclusions:**

Installation errors, abuse, misuse or crash damage. You must be the original owner of the product and can supply proof of purchase.

Baja Designs manufactures its own products as well as resells products manufactured by others. Baja Designs makes no express or implied warranties on products not manufactured by Baja Designs including without limitation any warranties or merchantability and fitness for a purpose. We will, however, pass on all warranties made by the manufacturer, who has sole responsibility for performing such warranties.

Baja Designs will pay the freight if your product is less than 90 days old, otherwise defective products must be returned to Baja Designs, Inc., freight prepaid. At our option, we will repair or replace items in question and return them at no charge. If the identical product is no longer available, we will replace with a similar product of equal value. Baja Designs Inc. will not be responsible for any indirect or consequential damages in connection with defective merchandise.

Items purchased through a Baja Designs authorized dealer must be returned through the dealer. Only available on LED auxiliary lights and product must be in sellable condition at MSRP. Product that has been damaged in any way after the original purchase date will be excluded from this guarantee.

### **Indemnification:**

**Buyer hereby acknowledges off-roading, racing and driving at night are dangerous activities and that the products and/or supplies purchased from Baja Designs are used in an inherently dangerous activity that may endanger life and limb; and in no event shall the seller, or seller's heirs and assigns, be held liable for consequential damages, nor shall seller's liability on any claim for damages arising out of or connected with the sale, delivery, or use of purchased products and/or supplies exceed the purchase price of the products and/or supplies.**

**Buyer is responsible for ensuring that it uses the products (and its vehicle) in accordance with all applicable laws, regulations, guidelines, and standards of care. Buyer acknowledges that some products may only be used when off-roading, and Buyer will comply with all vehicle and road safety guidelines. Buyer is solely responsible for (and will indemnify and hold Bestop harmless for) any claims, losses, damages, fines, fees, costs, or other amounts arising out of Buyer's non-compliance with these provisions.**

## Tundra Instructions Tools Required

- \* 4mm Allen wrench
- \* 9/16" wrench and socket
- \* Trim removal tool
- \* Phillips head screwdriver

**To begin, make sure the vehicle is in park, on level ground and the parking brake is engaged.**

1. Using a trim removal tool wrapped in masking tape, release the tabs holding in the bumper cover by prying outwards starting in Zone A then proceeding in alphabetical order. The bumper cover is held captive behind the left and right grill bezels but can be gently pried away to release. Once removed, place the bumper cover on a soft surface.

2. Using a Phillips head screwdriver, remove the bolts holding in the driver side OEM fog light. Disconnect the wiring connector from the back of the light.

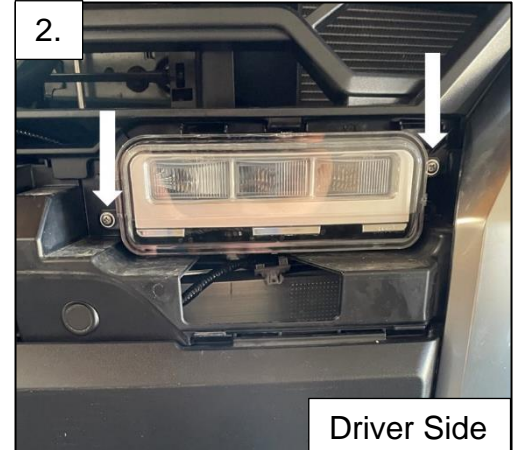
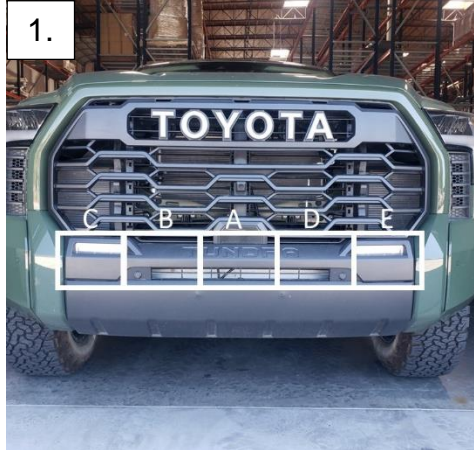

3. Add the 3/8" bolt and washer into the bracket and secure hand tight with a nut then using a 4mm Allen wrench, install the S2s into the standard light bracket. Repeat for the second light and once assembled, use a 9/16" wrench and socket to mount the two lights onto the driver side vehicle specific mount bracket.

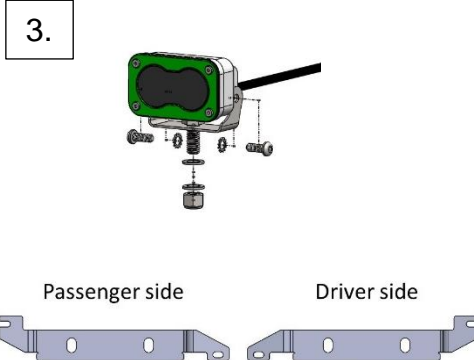

4. Plug in the wire harness adapters to the OEM fog light harnesses and the S2s. Carefully tuck the wires behind the light. Mount the new fog light assemblies into the truck using a Phillips head screwdriver and the OEM fog light screws.

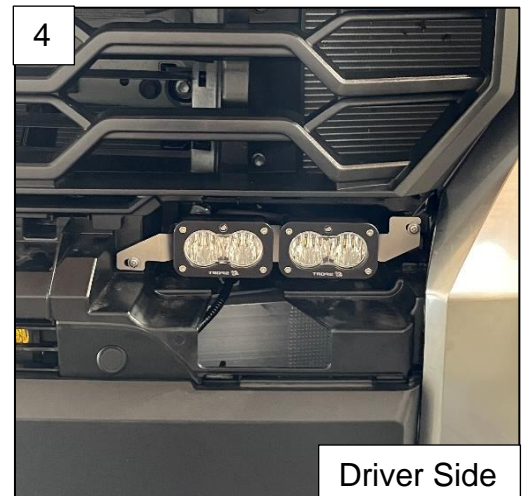

5. Repeat steps 2-4 for the passenger side. Check that the lights work when the vehicles fog lights are activated. Carefully reinstall the bumper cover starting near the grill bezels.

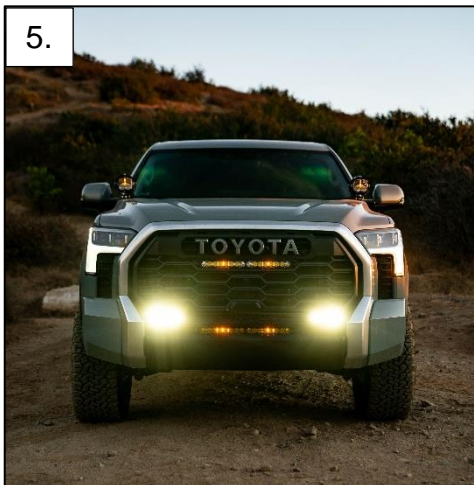

\*Tie all wires away from sharp, hot, and/or rotating components.

\* Re-torque all the fasteners after 100 miles.

\*Your install is now complete! Thank you for choosing Baja Designs.



## Tacoma Instructions

### Tools Required

\* 4mm Allen wrench  
\* Trim removal tool

\*9/16" wrench and socket  
\*Phillips head screwdriver

\*10mm socket and ratchet

**To begin, make sure the vehicle is in park, on level ground and the parking brake is engaged.**

1. With a 10mm socket, remove the bolts securing the felt under panel to the front clip. Remove the bolts that hold the front clip to the lower supports.

2. Disconnect the 3 electrical connectors on the passenger side of the front clip above the shutter system.

1.

2.



3. Gently pull the sides of the front clip out and forward to disconnect them from the vehicle. The furthest in clip will be behind the grill vent trim pieces. Repeat on the opposite side of the vehicle.

4. Remove the four push rivets securing the air box inlet to the vehicle and remove the inlet. With a 10mm socket, remove the 3 bolts holding the top of the grill to the core support (circled). Gently lift up and out on the front clip to remove it from the vehicle and place it face down on a soft work surface.

3.

4.



5. Remove the 6 bolts holding the shutter system in using a 10mm socket (circled). Use a Phillips head screwdriver to remove the small screws securing the front fog light cover. Stand the front clip up and remove the fog light cover starting at one end and disengaging the clips moving across.

6. Uninstall the factory fog light by removing the 2 Phillips head screws on either side and disconnecting the electrical connectors on the back.

5.

6.

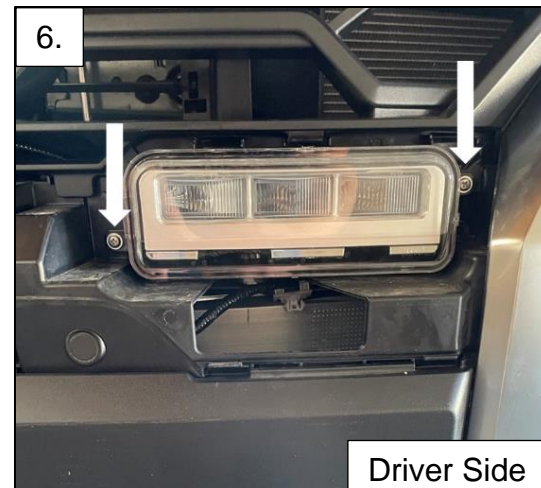
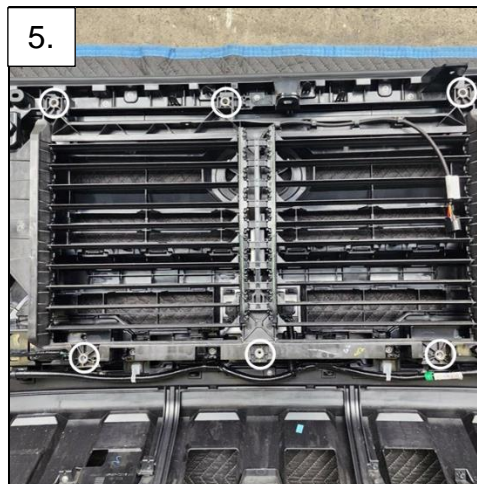

Driver Side

7. Add the 3/8" bolt and washer into the bracket and secure hand tight with a nut then using a 4mm Allen wrench, install the S2s into the standard light bracket. Repeat for the second light and once assembled, use a 9/16" wrench and socket to mount the two lights onto the driver side vehicle specific mount bracket.

8. Plug in the wire harness adapters to the OEM fog light harnesses and the S2s. Carefully tuck the wires behind the light. Mount the new fog light assemblies into the truck using a Phillips head screwdriver and the OEM fog light screws.

7.

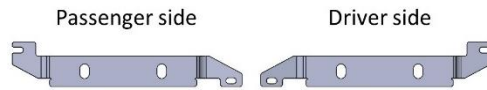
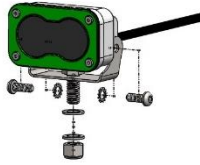

8.

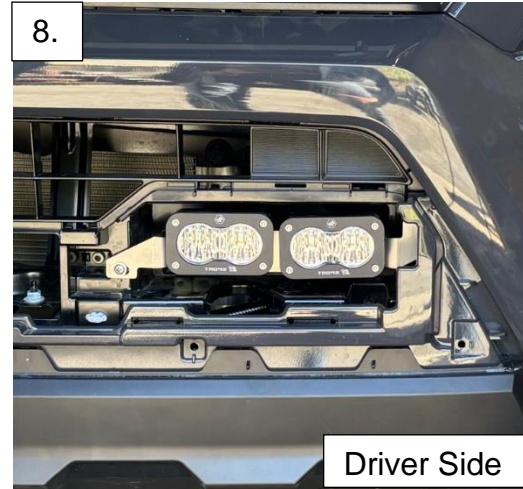

Driver Side

9. Reinstall the front clip by following steps 1-5 in reverse.

9.



\*Tie all wires away from sharp, hot, and/or rotating components.

\* Re-torque all the fasteners after 100 miles.

\*Your install is now complete! Thank you for choosing Baja Designs.