



baja designs[®]
THE SCIENTISTS OF LIGHTING

Toyota, Tacoma (12'-20'), 4Runner (10'-20'), Tundra (14'-20'), Squadron Fog light kit Instructions



185 Bosstick Boulevard • San Marcos • CA • 92069

Phone 760-560-2252 x3 • Fax 760-560-0383

info@bajadesigns.com • www.bajadesigns.com



baja designs®
THE SCIENTISTS OF LIGHTING

LIMITED LIFETIME WARRANTY

Baja Designs proudly offers a LIFETIME WARRANTY against manufacturer's defect on all the products that we manufacture.

These are comprehensive warranties; other than the exclusions below – you're covered. If your LED or HID bulb burns out, you're covered. Additionally, cutting off our connector or changing your lenses does not automatically void your warranty.

Exclusions:

Installation errors, abuse, misuse or crash damage. You must be the original owner of the product and can supply proof of purchase.

Baja Designs manufactures its own products as well as resells products manufactured by others. Baja Designs makes no express or implied warranties on products not manufactured by Baja Designs including without limitation any warranties or merchantability and fitness for a purpose. We will, however, pass on all warranties made by the manufacturer, who has sole responsibility for performing such warranties.

Baja Designs will pay the freight if your product is less than 90 days old, otherwise defective products must be returned to Baja Designs, Inc., freight prepaid. At our option, we will repair or replace items in question and return them at no charge. If the identical product is no longer available, we will replace with a similar product of equal value. Baja Designs Inc. will not be responsible for any indirect or consequential damages in connection with defective merchandise.

Items purchased through a Baja Designs authorized dealer must be returned through the dealer. Only available on LED auxiliary lights and product must be in sellable condition at MSRP. Product that has been damaged in any way after the original purchase date will be excluded from this guarantee.

Indemnification:

Buyer hereby acknowledges off-roading, racing and driving at night are dangerous activities and that the products and/or supplies purchased from Baja Designs are used in an inherently dangerous activity that may endanger life and limb; and in no event shall the seller, or seller's heirs and assigns, be held liable for consequential damages, nor shall seller's liability on any claim for damages arising out of or connected with the sale, delivery, or use of purchased products and/or supplies exceed the purchase price of the products and/or supplies

Toyota, Tacoma/4Runner/Tundra Squadron Fog Light Kit Instructions

Tools Required

- Phillip's Head Screwdriver
- 10mm Socket Wrench
- Test light, or Multimeter
- Trim Tool (Or Flathead Screwdriver)
- 4mm Allen Wrench
- Scissors

Tacoma and 4Runner Only:

(14+) 4Runner Limited instructions on next page

1. To begin, place vehicle into park with the ignition off.
2. With the 10mm socket and trim tool (or flathead screwdriver), remove all the inner fender fasteners at the front of the wheel well to gain access to behind the fog light. Alternatively, you may be able to open the hood and reach behind the headlight to access the inner fog light area. **4Runner** models will have a plastic core support cover. To remove cover, use the flathead or trim tool to unclip and pry out the plastic fasteners. (2019 Tacoma shown, years/models vary)
3. Unplug the OEM fog light connector (Arrow). With the Phillip's Head screwdriver, remove the mounting screw/screws (Circle) and place the light aside.
4. With the provided hardware, mount the brackets to the lights using the 4mm Allen wrench. Be sure to place the serrated washers in between the brackets and the lights. (Use image for reference).
5. Place the light assembly into the fog mounting slots and place the screws into their holes and tighten. OEM vehicle body tolerances can vary. If there is play withing the slots and/or uneven gaps between the OEM plastic bezel and the fog light bezel, adhesive backed rubber pads are included to be placed on the brackets within the slots to create a tailored fit. Use scissors to trim the excess rubber. **(The passenger side of the 4Runner has a splash guard that needs to be removed and left off. Use the flathead/trim tool to pry the piece off the inside of the fog light.)**
6. Locate the fog light plug 'n play adapters. For a moment, turn on the vehicle, headlights, and fog lights. Determine which wire on the OEM fog light connector has (+) voltage and which wire is ground (-).
7. Turn vehicle off. Plug in the wiring adapters. The (+) wire will need to be inserted into the provided plug in the (B) pin location. The ground will then be inserted into the (A) location.
8. Replace the fender well and all associated fasteners. Repeat steps 1-8 for the opposite side.

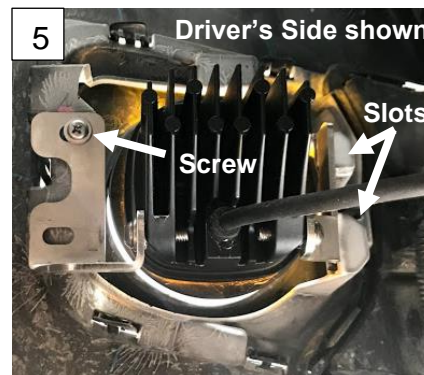
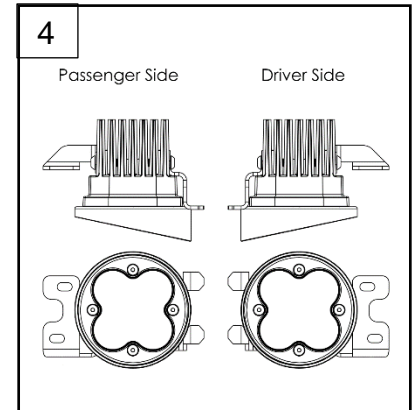
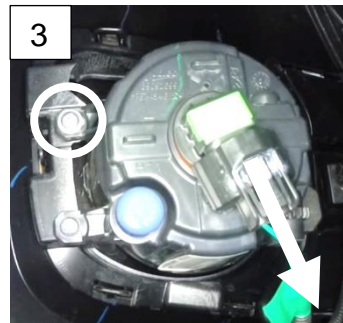

4Runner Limited (14+):

1. To begin, place vehicle into park with the ignition off.
2. With the 10mm socket and trim tool (or flathead screwdriver), remove all the inner fender fasteners at the front of the wheel well to gain access to behind the fog light. (Driver's side shown)
3. Remove the white clip (arrow) and then use the Phillip's head screwdriver to remove the screw (circle)
4. Use the trim tool, or flathead screwdriver to pry up and release the plastic fastener's that hold the plastic core support cover. Then pry out each fastener and place core support cover aside.
5. Reach behind the top of the bumper to remove the two remaining white clips that hold the fog light shroud to the bumper. Unplug the fog light connector. With the Phillip's head screwdriver, remove the OEM fog lights.
6. With the provided hardware, mount the brackets to the lights using the 4mm Allen wrench. Be sure to place the serrated washers in between the brackets and the lights. (Use step 4 image on page 3 for reference).
7. Place the light assembly into the fog mounting slots and place the screws into their holes hand tight. Tighten screws. OEM vehicle body tolerances can vary. If there is play withing the slots and/or uneven gaps between the OEM plastic bezel and the fog light bezel, adhesive backed rubber pads are included to be placed on the brackets within the slots to create a tailored fit. Use scissors to trim the excess rubber. **(The passenger side of the 4Runner has a splash guard that needs to be removed and left off. Use the flathead/trim tool to pry the piece off the inside of the fog light.)**
8. Locate the fog light plug 'n play adapters. For a moment, turn on the vehicle, headlights, and fog lights. Determine which wire on the OEM fog light connector has (+) voltage and which wire is ground (-).
9. Turn vehicle off. Plug in the wiring adapters. The (+) wire will need to be inserted into the provided plug in the (B) pin location. The ground will then be inserted into the (A) location.
10. Replace the fog light shroud, fender well, and all associated fasteners. Repeat steps 1-9 for the opposite side.

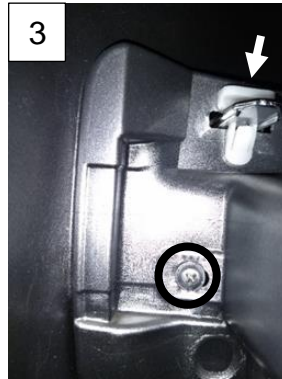

Tundra Only:

**12mm socket, 7/16" socket, and 7/16" wrench needed in addition to the other tools listed.*

1. To begin, place vehicle into park with the ignition off.
2. With the 10mm socket, 12mm socket, and trim tool (or flathead screwdriver) remove the lower splash guard at the bottom edge of the front wheel well. Then remove all the inner fender fasteners at the front of the wheel well to gain access to behind the fog light. (Driver's side shown)
3. Unplug the fog light connector. Remove the blue clip that locks the fog light assembly into the bumper. Press the top detent (circled in second image) of the fog light shroud to remove the OEM fog light assembly. Place the included rubber pads in the locations shown.
4. With the Phillip's head screwdriver, remove the OEM fog lights from the shrouds.
5. With the provided hardware, mount the brackets to the lights using the 4mm Allen wrench. Be sure to place the serrated washers in between the brackets and the lights. (Use step 4 image on page 3 for reference).
6. Place the light assembly into the fog mounting slots and place the screws into their holes hand tight. Tighten screws. With the provided 1/4" hardware, place it onto the fog light bracket as shown in the remaining hole. Place rubber cap over the end of the bolt. Re-install the fog light assembly into the bumper and replace the blue locking clip.
7. Locate the fog light plug 'n play adapters. For a moment, turn on the vehicle, headlights, and fog lights. Determine which wire on the OEM fog light connector has (+) voltage and which wire is ground (-).
8. Turn vehicle off. Plug in the wiring adapters. The (+) wire will need to be inserted into the provided plug in the (B) pin location. The ground will then be inserted into the (A) location.
9. Replace the fender well, splash guard, and all associated fasteners. Repeat steps 2-9 for the opposite side.

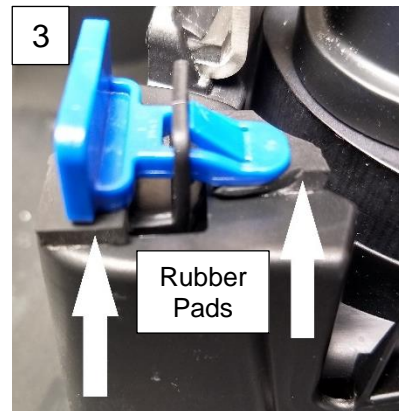
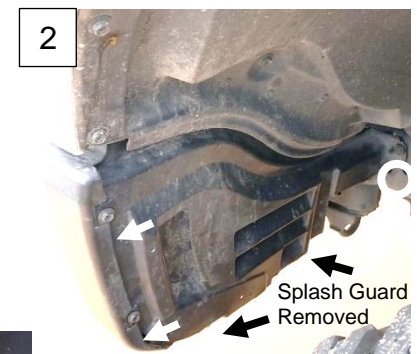
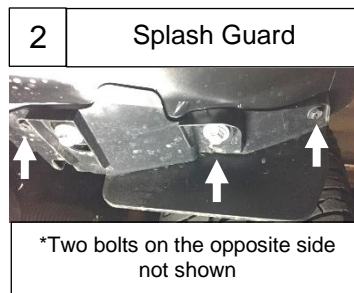

Re-torque all the fasteners after 100 miles.

Your install is now complete! Thank you for choosing Baja Designs.