



Installation Instructions TrailMax™ II Fold and Tumble Rear Seat

Vehicle Application

•Jeep Wrangler

1997 – 2006

Vinyl Seat

Part Number: 39435



•Jeep Wrangler



1997 – 2006

Cloth Seat

Part Number: 39439

www.Bestop.com - We're here to help! Visit our web site and click on ["Ask a Question"](#). Click here for more [Jeep Accessories by Bestop](#).

INSTALLATION TIME	SKILL LEVEL
 1/2 Hour	 1 - Easy

TOOLS		
 Wrench 13 mm	 Torx Wrench T-50	 Safety Glasses





Installation Tips

Before you begin installing this assembly, read all instructions thoroughly.

For a smooth fit:

For ease in installation, the product should be installed at temperatures above 72° F. Below this temperature, the fabric may contract an inch or more, making it difficult to fit to the vehicle. It is normal for fabric to contract and wrinkle when stored in the shipping carton. Within a few days after the installation, the fabric will relax and the wrinkles will disappear.

 **CAUTION** Safety glasses should be worn at all times while installing this product.

 **WARNING** This product is designed primarily to enhance the appearance of the vehicle and to shield the occupants from ordinary weather conditions. Do not rely in any way on the components of this product to contain occupants within the vehicle, or to protect against injury or death in the event of an accident. This product will not protect the occupants from falling objects. Never operate the vehicle in excess of manufacturer's specifications.

WEAR SEAT BELTS AT ALL TIMES

Read and follow, precisely, all installation instructions provided when installing product. Failure to do so may result in a poor fit and could place occupants of the vehicle in a potentially dangerous situation.

TrailMax™ II Fold and Tumble Rear Seat – Installation Instructions

Parts List and Hardware Identification

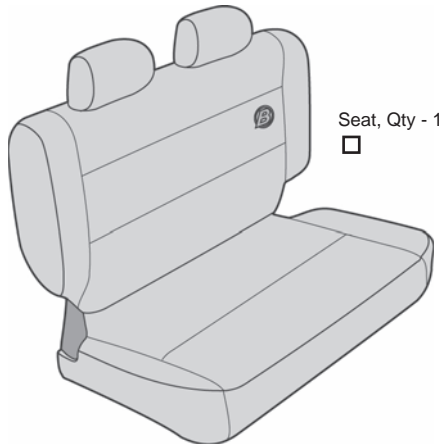

Parts Kit, Part Number 444.25, Qty - 1

Striker Plate, Qty - 1

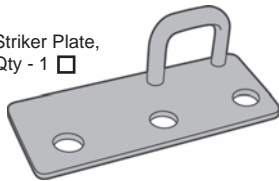

E-Clips, Qty - 2

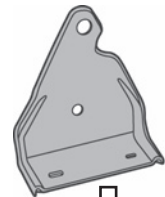

Floor Mounting Bracket, Lt., Qty - 1

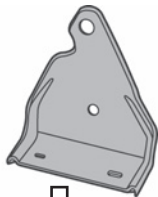

Floor Mounting Bracket, Rt., Qty - 1

1 Remove the Existing Rear Seat

Remove the old rear seat. Remove the existing front mounting brackets. Discard the brackets, but set the bolts aside to be used to install the new seat.



WARNING

If your vehicle has carpet covering the floor, cut the carpet so that the Floor Mounting Brackets are installed flush on the metal floor. If the Floor Mounting Brackets are not flush mounted, the seatback may not lock in place, which could result in serious injury to you and others.

2 Left Floor Mounting Bracket Installation

Locate the Left Floor Mounting Bracket with the cutout toward the front of the vehicle. Align the holes in the bracket with the holes behind the seat riser in the vehicle. Use two of the original bolts that were removed in Step 1 to install the Floor Mounting Bracket. Securely tighten the bolts.

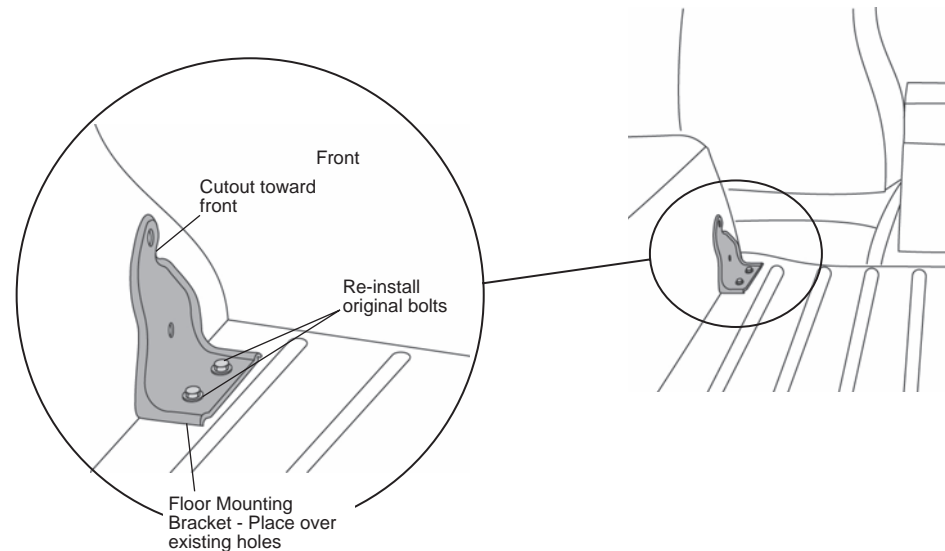

TrailMax™ II Fold and Tumble Rear Seat – Installation Instructions



WARNING

Failure to install the E-Clip may result in the seat moving off the Front Brackets which could result in serious injury to you and others.

3 Slide Seat onto Left Front Mounting Bracket

Orient the Seat, with the Legs on the bottom of the seat facing the rear of the vehicle. Fold the Seat back down into the closed position. Place the Seat in the vehicle

Locate the pivot pin on the front left side of the Seat. Slide the pin into the hole in the Left Front Mounting Bracket. Slide an E-Clip over the pin so that it catches in the notch in the pin.

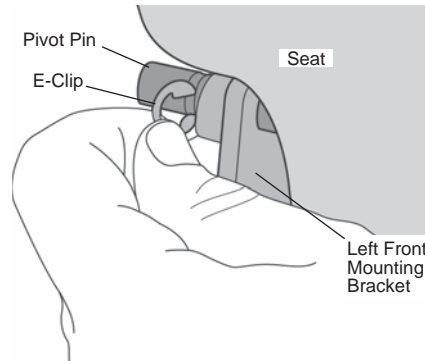

4 Install Right Front Mounting Bracket

Orient the Right Floor Mounting Bracket with the cutout toward the front of the vehicle and slide it over the pivot pin on the front right side of the seat. Secure the bracket to the seat with the remaining E-Clip. Align the holes in the bracket with the holes in the floor. Use the two remaining original bolts that were removed in Step 1 to install the Floor Mounting Bracket. Securely tighten the bolts.

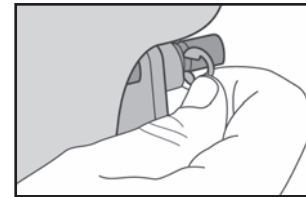

Install Right Front Mounting Bracket on Seat with E-Clip

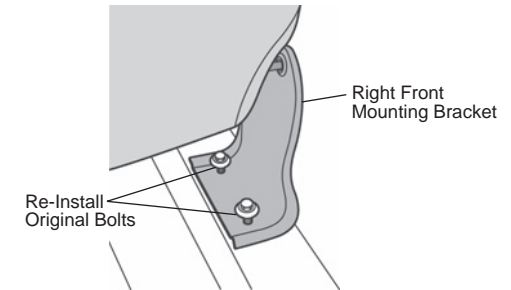

5 Install Striker Plate

Remove the Seat Belt Mounting Bracket and set it aside to be reinstalled.

Orient the Striker Plate with the raised catch toward the rear of the vehicle. Place the plate in the vehicle with the middle hole over the hole from the seat belt bracket and the catch toward the rear. Re-place the Seat Belt Mounting Bracket on top of the Striker Plate and align the hole in the bracket with the middle hole in the plate. Re-install the bolt to secure the Seat Belt Mounting Bracket and the Striker Plate.

Tumble the Seat back and hook the lock on the rear of the seat to the catch on the Striker Plate.

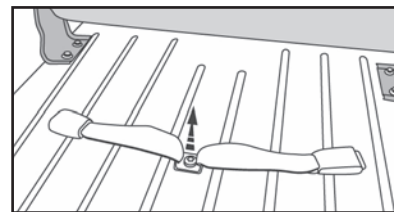

Remove Seat Belt Mounting Bracket

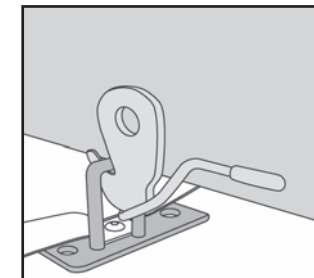
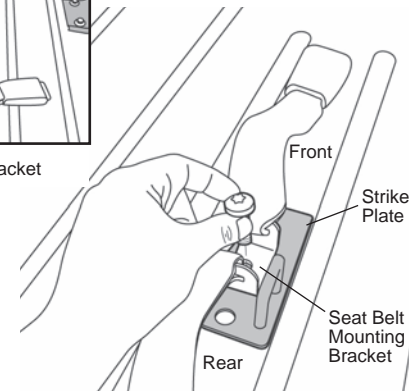

Hook Seat Latch to Striker Plate

TrailMax™ II Fold and Tumble Rear Seat – Installation Instructions

Care and Maintenance of your Bestop Product

Your Bestop product is made of the finest materials available. To keep it looking new and for the maximum possible wear, it will need periodic cleaning and maintenance.

Washing: The fabric should be washed often using soap, warm water and a soft bristle brush. Rinse with clear water to remove all traces of soap or use Bestop-recommended Bestop Cleaner and Bestop Protectant. Bestop Cleaner and Bestop Protectant are specially formulated to provide a total cleaning and protection system. Bestop Cleaner will not harm vehicle finish, is biodegradable and environmentally friendly. Bestop Protectant protects against UV-fading, cracking and hardening.

LIMITED WARRANTY

We warrant our product to be free from defects in material and workmanship, for the terms specified below, provided there has been normal use and proper maintenance. This warranty applies to the original purchaser only. All remedies under this warranty are limited to the repair or replacement of any item or items found by the factory to be defective within the time period specified. If you have a warranty claim, first you must call our factory at the number below for instructions. You must retain proof of purchase and submit a copy with any items returned for warranty work. Upon completion of warranty work, if any, we will return the repaired or replaced item or items to you freight prepaid. Damage to our products caused by accidents, fire, vandalism, negligence, misinstallation, misuse, Acts of God, or by defective parts not manufactured by us, is not covered under this warranty.

THE WARRANTY TIME PERIOD IS AS FOLLOWS FOR REPLACE-A-TOP™, SAILCLOTH REPLACE-A-TOP™, SUPERTOP®, SUPERTOP® REPLACEMENT SKINS, SUNRIDER®, AND TIGERTOP®: TWO YEARS FROM DATE OF PURCHASE.

THE WARRANTY TIME PERIOD IS AS FOLLOWS FOR ALL OTHER "SOFT GOODS" MANUFACTURED BY OUR COMPANY (USING PRIMARILY VINYL, PLASTICS, AND/OR FOAM): ONE YEAR FROM DATE OF PURCHASE.

THE WARRANTY TIME PERIOD IS AS FOLLOWS FOR ALL OTHER "HARD GOODS" MANUFACTURED BY OUR COMPANY (USING PRIMARILY METALS, PLASTICS, AND/OR FIBERGLASS): ONE YEAR FROM DATE OF PURCHASE.

ANY IMPLIED WARRANTIES OF MERCHANTABILITY AND/OR FITNESS FOR A PARTICULAR PURPOSE CREATED HEREBY ARE LIMITED IN DURATION TO THE SAME DURATION AND SCOPE AS THE EXPRESS WRITTEN WARRANTY. OUR COMPANY SHALL NOT BE LIABLE FOR ANY INCIDENTAL OR CONSEQUENTIAL DAMAGE.

Some states do not allow limitations on how long an implied warranty lasts, or the exclusion or limitation of incidental or consequential damages, so the above limitations or exclusions may not apply to you. This warranty gives you specific legal rights, and you may also have other rights which vary from state to state.



For further information or request for warranty work, please contact:

Bestop Inc., Customer Service
Toll-Free: (800)845-3567
Main: (303)465-1755
E-mail: csbestop@Bestop.com
Website: www.Bestop.com