

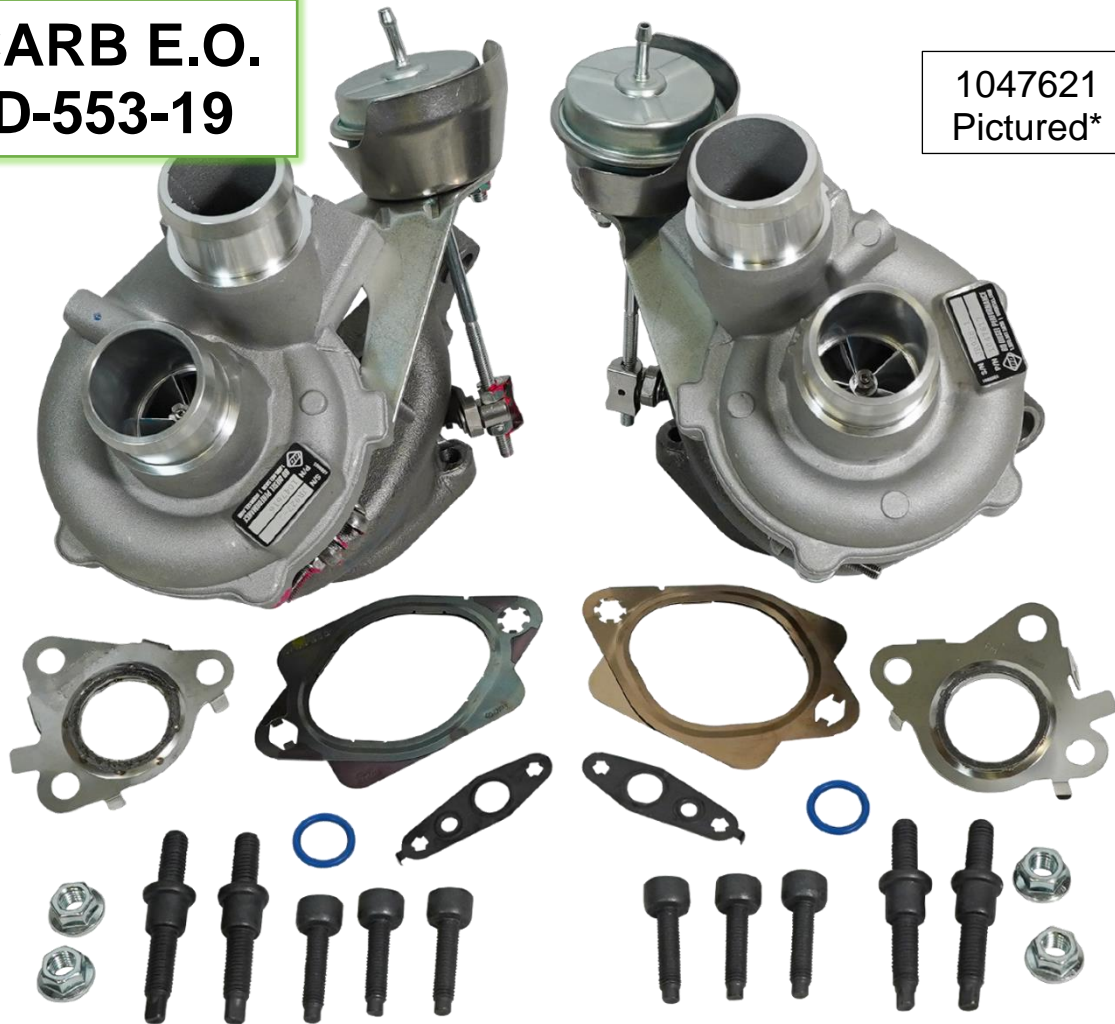

**DOWNLOAD COLOUR
INSTALL MANUALS AT
www.bddiesel.com**

**CARB E.O.
D-553-19**

1047621
Pictured*





Ford 11-16 3.5L Screamer

Screamer Turbos for 2011-2016 Ford F150 3.5L

1047620	1047611	2011-2012 Ford F150 3.5L Ecoboost, Driver's Side
	1047612	2011-2012 Ford F150 3.5L Ecoboost, Passenger's Side
1047621	1047616	2013-2016 Ford F150 3.5L Ecoboost, Driver's Side
	1047617	2013-2016 Ford F150 3.5L Ecoboost, Passenger's Side



Kit Contents

1047611 (2011-2012) Driver Side



	W716667-S900	W715673-S900
		
11-12 Screamer, Driver Side	Stud; Ford Downpipe	Bolt; Ford M8x1.25-30mm
Qty: 1	Qty: 2	Qty: 3

FT-90702	GS33741	
		
Nut; M10x1.5 Flange	Gasket Kit; Driver Side	Plastic Syringe
Qty: 2	Qty: 1	Qty: 1



1047612 (2011-2012) Passenger Side

	W716667-S900	W715673-S900
		
11-12 Screamer, Passenger Side	Stud; Ford Downpipe	Bolt; Ford M8x1.25-30mm
Qty: 1	Qty: 2	Qty: 3

FT-90702	GS33742	
		
Nut; M10x1.5 Flange	Gasket Kit; Passenger Side	Plastic Syringe
Qty: 2	Qty: 1	Qty: 1

1047616 (2013-2016) Driver Side		
	W716667-S900	W715673-S900
		
13-16 Screamer, Driver Side Qty: 1	Stud; Ford Downpipe Qty: 2	Bolt; Ford M8x1.25-30mm Qty: 3

FT-90702	GS33741	
		
Nut; M10x1.5 Flange Qty: 2	Gasket Kit; Driver Side Qty: 1	Plastic Syringe Qty: 1

1047617 (2013-2016) Driver Side		
	W716667-S900	W715673-S900
		
13-16 Screamer; Passenger Side Qty: 1	Stud; Ford Downpipe Qty: 2	Bolt; Ford M8x1.25-30mm Qty: 3

FT-90702	GS33742	
		
Nut; M10x1.5 Flange Qty: 2	Gasket Kit; Passenger Side Qty: 1	Plastic Syringe Qty: 1

Table of Contents

- Kit Contents2
- Table of Contents.....4
- Introduction4
- Preface4
- Tools Required for Installation4
- Installation.....5
 - Turbo Removal5
 - Installation14

Introduction

The Screamer turbo for the 2011-2016 Ford F150 3.5L Ecoboost provides a Raptor-sized upgrade. A larger compressor wheel provides higher mass airflow which can provide more power for your truck while maintaining reliability for years to come.

Preface

The kit contains several items that may cause confusion:

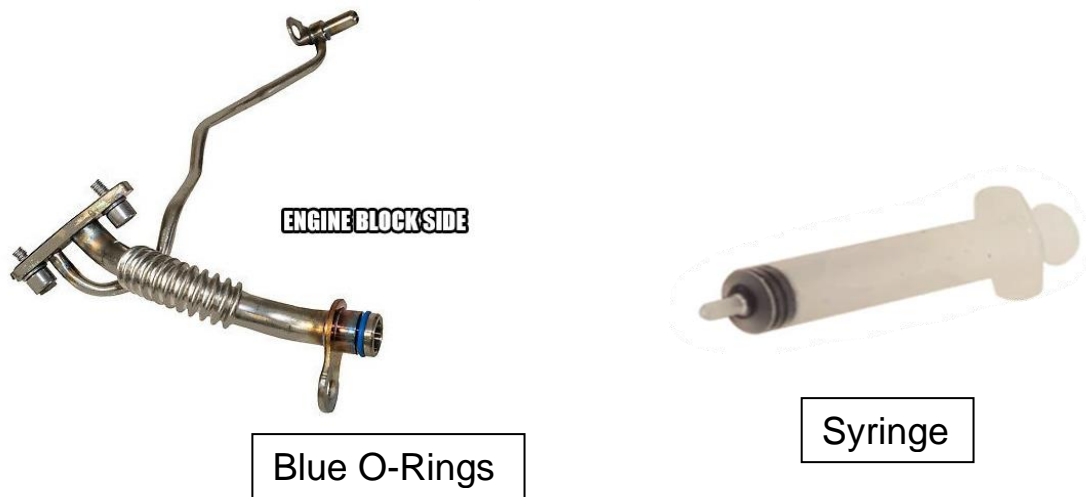

The provided blue O-rings are intended for the oil drain tube, while it is not necessary to replace this part, stock OEM O-rings can leak, and we have provided this part if you wish to replace the O-ring while installing this kit.

One or two syringes are provided within the kit (depending which kit was purchased) to pre-lube the turbochargers prior to install. This is intended to eliminate the small amount of the time that the turbo will run dry during first start.

Tools Required for Installation

- In-lb torque wrench
- Ft-lb torque wrench
- 3/8” quick disconnect tool
- Torx heads (variety)
- High temperature nickel anti-seize
- Jackstand

Installation

Turbo Removal

Secure the vehicle by blocking wheels and setting on jack stands or hoist.

Disconnect vehicle battery before installation.



If equipped, remove the retainers and the transmission housing cover. Remove the bolts and the skid plate/splash shield.

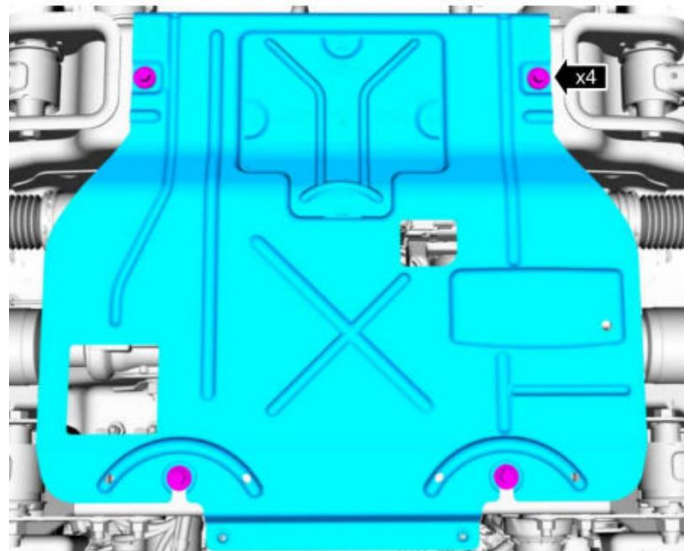

Remove the wheels and fender liners.

Note: Be sure to unclip all electrical connectors from the inner side of the fender liner before removing them



Locate the radiator drain on the passenger side of the radiator and drain the coolant from the system.



Remove the oil filler cap and remove the engine cover.

Reinstall the oil filler cap.

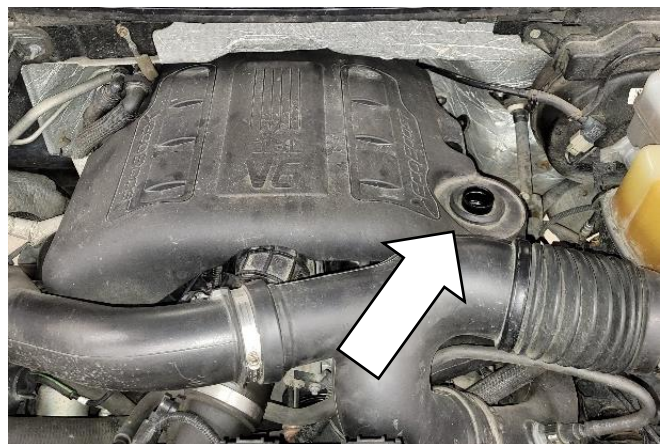

Disconnect the MAF sensor in the intake pipe.

Loosen the clamps to the lid and pipes and remove the Upper Air Cleaner Lid and Y-Pipe.

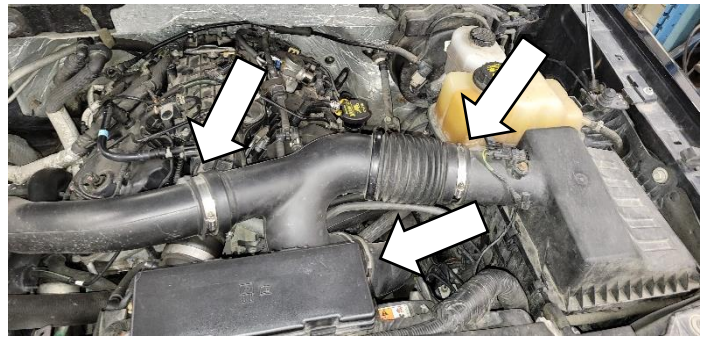

Disconnect the PCV pressure sensor electric connector, PCV tube quick connect couplings and remove the PCV tube.

Disconnect the quick release couplings and the turbo bypass tube.

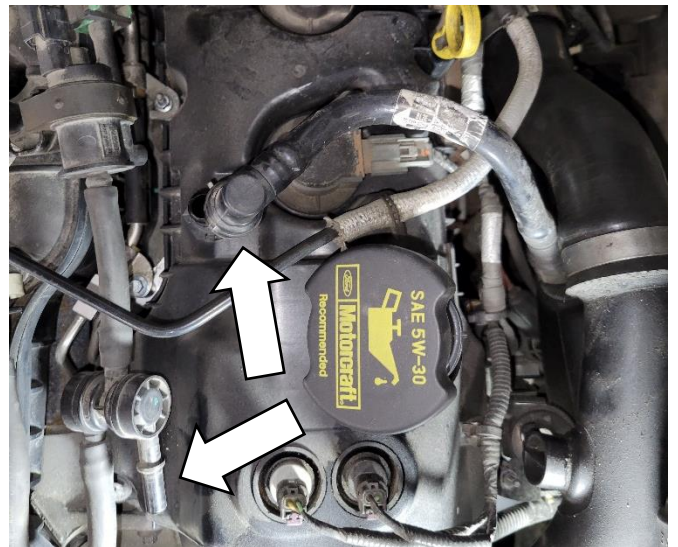

Loosen the clamps on the pipes which mount to the turbocharger and gently remove hose from the compressor cover.



Loosen the intercooler to inlet pipe clamps located between front bumper and radiator.

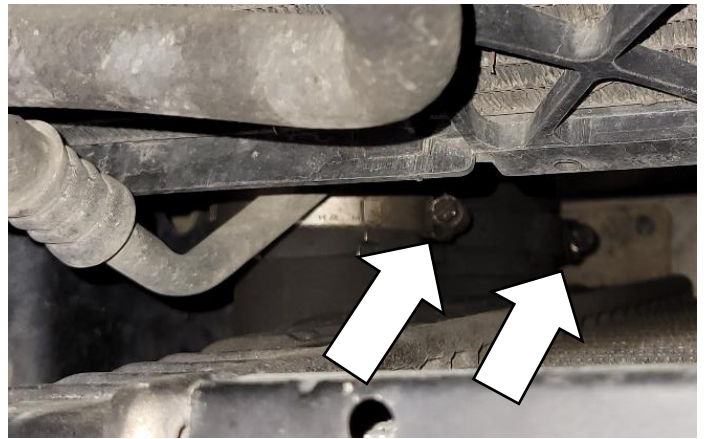

Release the turbo inlet & outlet tube from the bracket grommet and remove the inlet & outlet tube.

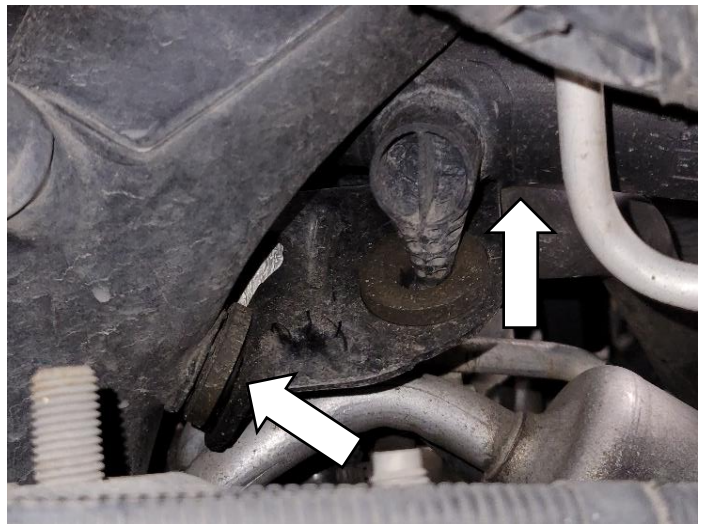

Disconnect the boost sensor and disconnect the pipe from the throttle valve and remove to allow for removal of the driver side turbocharger outlet pipe.

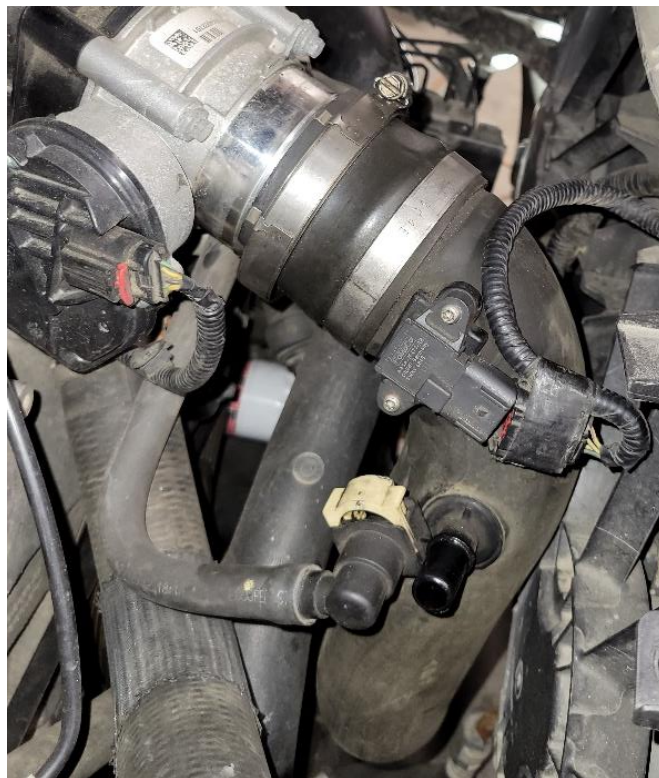

Disconnect the vacuum line from the passenger side turbocharger outlet pipe and remove the pipe.



With all the clamps loose, follow the process below for removal;

- Remove Passenger Inlet pipe (1)
- Remove Passenger Charge pipe (2)
- Shift the Driver charge pipe away from turbo
- Remove Driver Inlet pipe (3)
- Remove Driver Charge pipe (4)

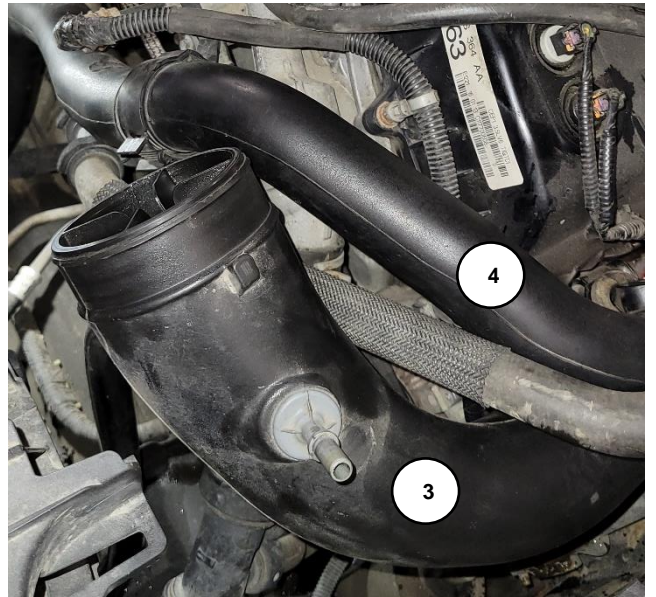
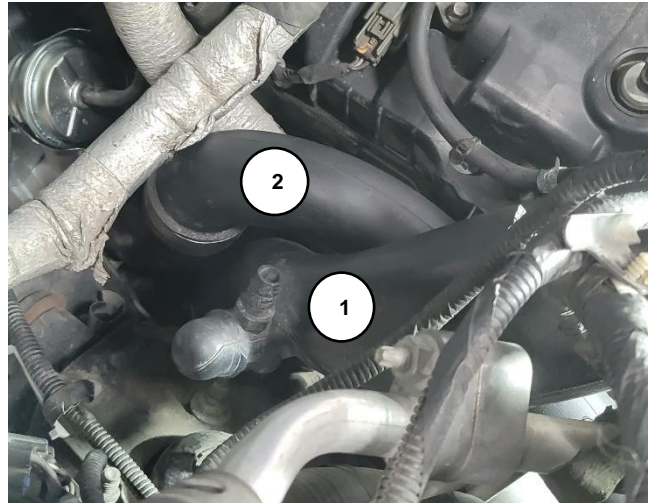

On the passenger side of the engine bay, Remove the nut securing the transmission cooler line support then slide support off of stud.

Remove the 2 bolts holding the starter on and shift the starter position to allow for access to the turbocharger for removal.

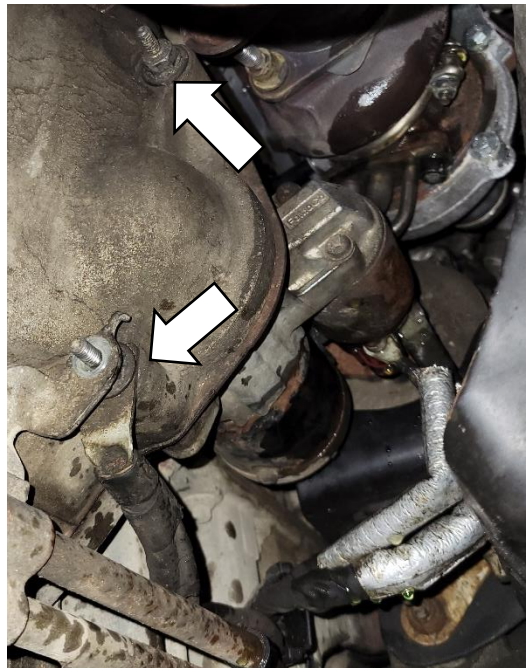

Remove and discard the 2 catalytic converter-to-turbocharger mounting flange nuts on both sides of the vehicle.

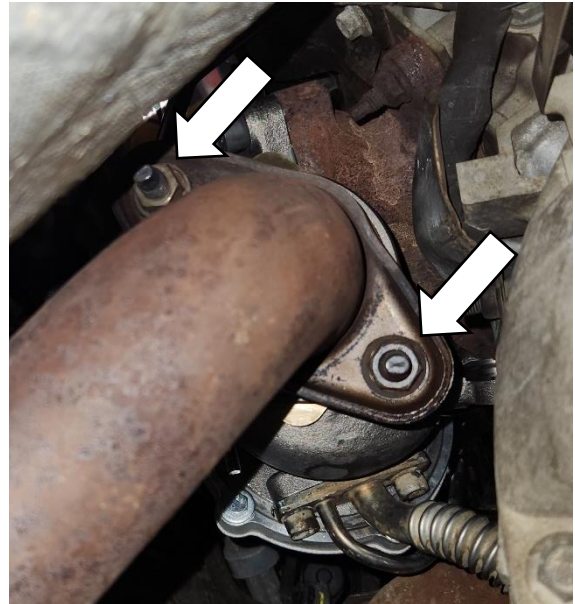

With the exhaust disconnected, adjust the exhaust rearward to ensure clearance between the turbocharger flanges and the downpipes.

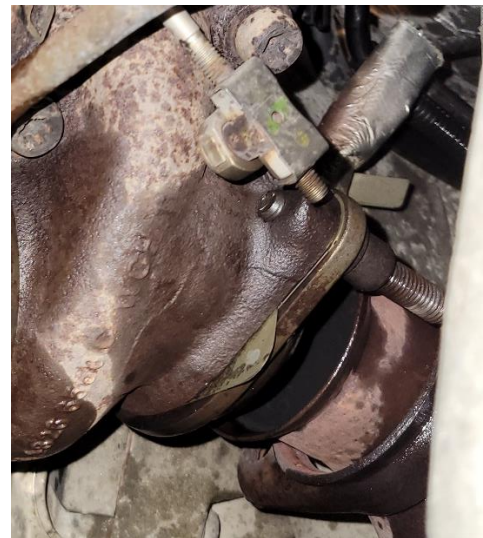

On the driver side of the frame, remove the 2 heat shield bolts and the heat shield.

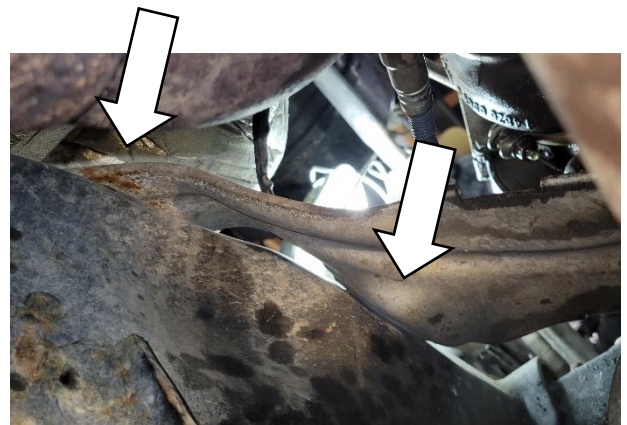

Remove the retaining clip in the coolant fitting on the top of the turbo and disconnect the coolant supply tube at the turbocharger.

Repeat on Passenger side.

Note: Passenger side upper coolant tube needs to be completely removed at the turbo and rear of engine block. Remove clips at either end.

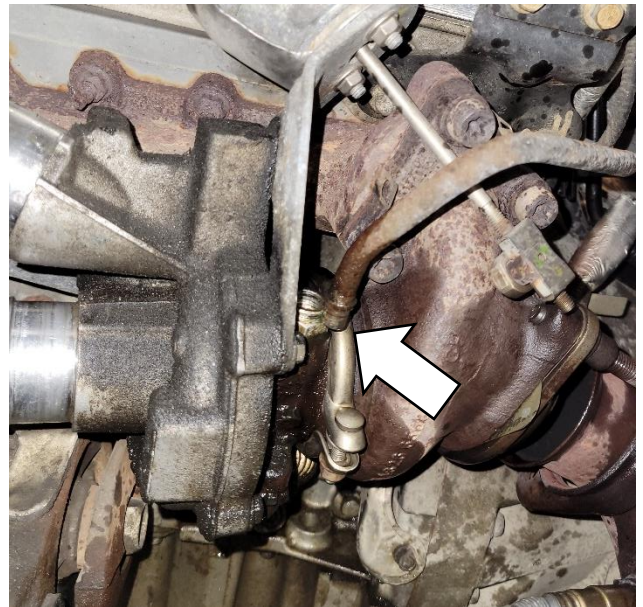

2011-2012 Turbocharger

Disconnect the turbocharger bypass valve electrical connector

Disconnect the wastegate hose and the 2 bypass vacuum hoses

Remove the bypass valve from its bracket and position.

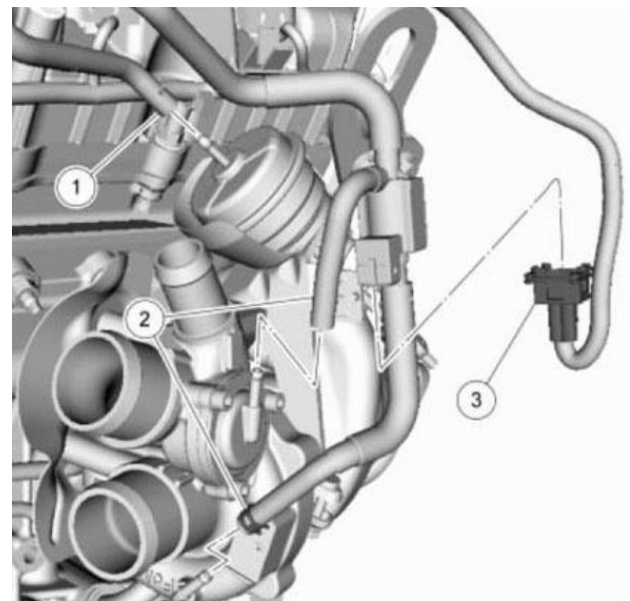

2013-2016 Turbocharger

Disconnect the wastegate hose.



Remove the 2 turbocharger center housing bolts for the oil return tube.

Remove and discard the oil return tube assembly gasket.

Note: Cover the oil drain assembly as the coolant line on the side of the turbo will drain onto the flange once disconnected.

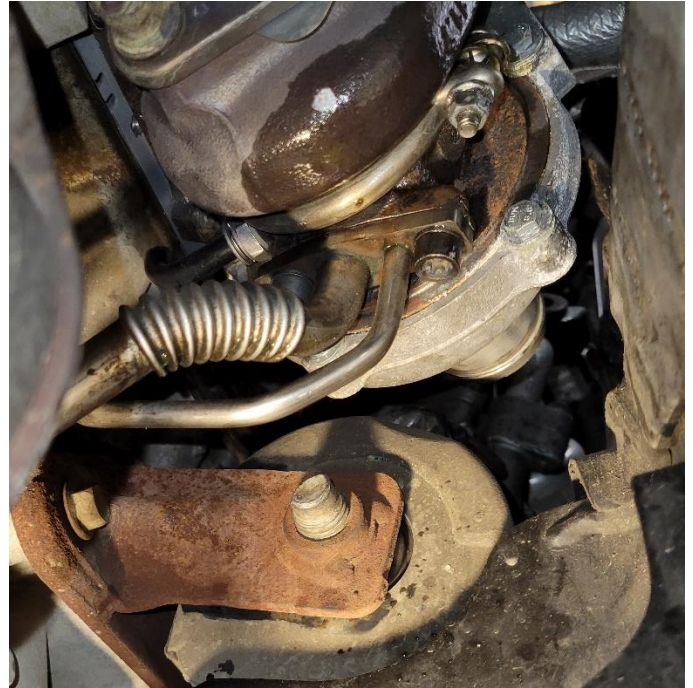

2011-2012 Trucks Only

Remove the turbocharger bracket bolt.

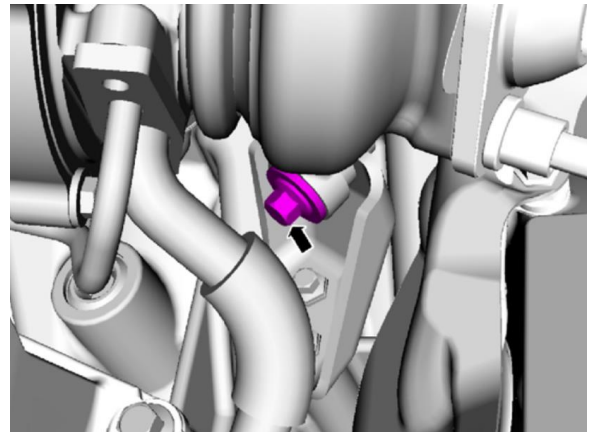

Remove the retaining clip on the coolant fitting on the inside turbo. Disconnect the coolant return tube at the turbo. Remove the 3 turbo mounting bolts and the turbo.

Discard the turbo exhaust manifold gasket.

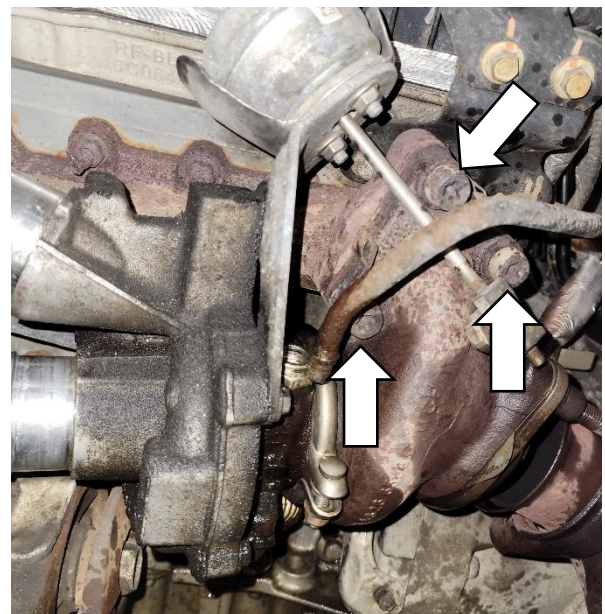

Remove the 2 remaining bolts holding the oil drain assembly.

Remove the clip holding the oil feed at the side of the engine block and remove the oil return tube assembly.

Remove and discard the oil return tube o-ring.

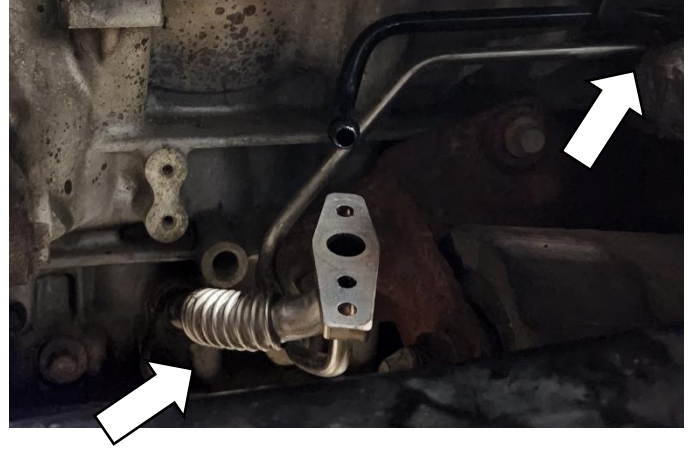

Remove and discard the turbo gasket.

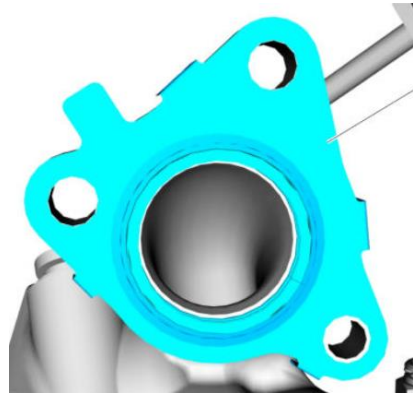

Remove the 2x turbo exhaust flange stud bolts and exhaust flange.

Discard the 2x turbo exhaust flange stud bolts and the exhaust flange gasket.

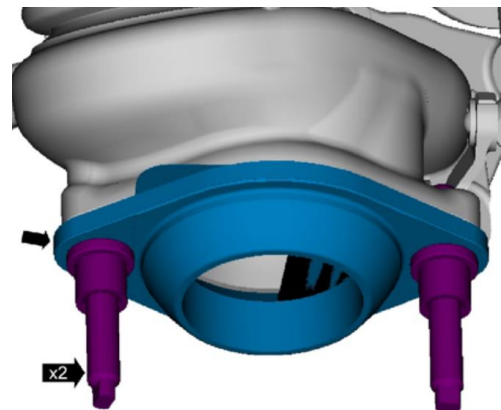

Repeat removal steps on opposite turbocharger

Installation

Apply high-temperature nickel anti-seize to the turbo exhaust flange stud bolts.

Install the turbo exhaust flange gasket, the exhaust flange, and the 2 new exhaust flange stud bolts.

Torque to **40 Nm (30 lb-ft)**.

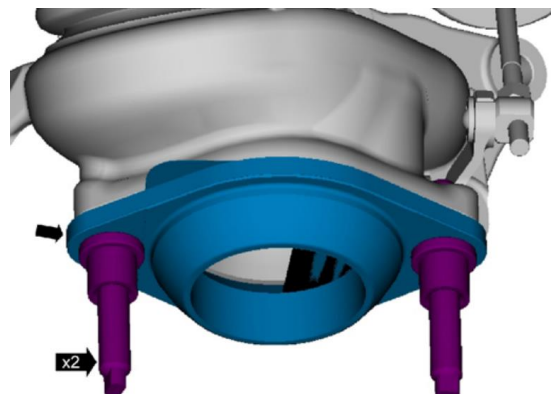

Install the new turbo gasket onto the turbo flange.

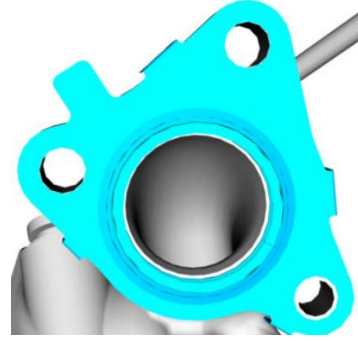

Install new oil return tube o-ring and install the oil return tube assembly. Reinstall retaining clips.

Note: Apply clean engine oil to the o-ring and cylinder block bore.

Note: Ensure that the oil supply tube is positioned in the cylinder block while installing the return tube assembly.



Install the new turbocharger oil inlet gasket.

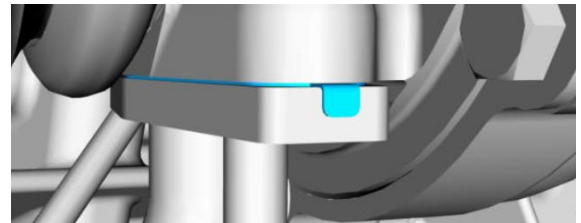

Install the new turbo into position with the 3 turbo mounting bolts into the manifold.

Be sure to have the inner coolant line in position prior to install with retaining clips as the line is held into position by the turbocharger.

Tighten to **32 Nm (24 lb-ft)**.

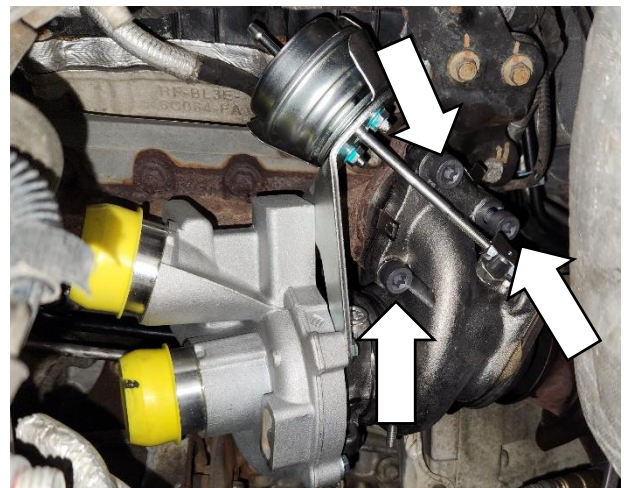
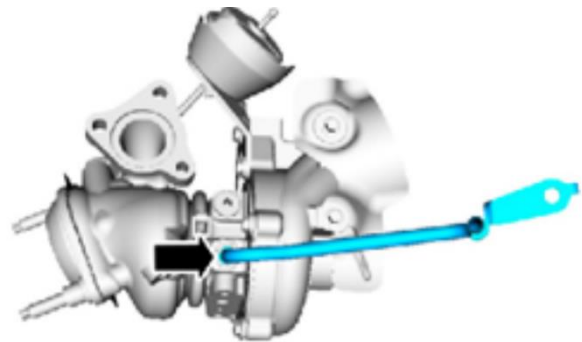

2011-2012 Trucks Only

Install the turbo bracket bolt and torque to **28 Nm (21 lb-ft)**.

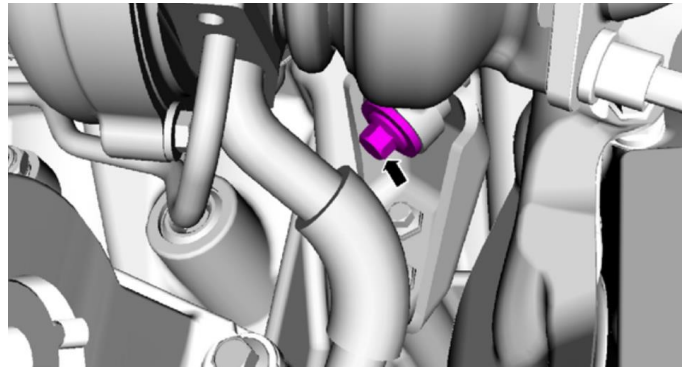

Install the 2 oil inlet/drain bolts. Tighten in the following stages:

- Install oil inlet side bolt halfway.
- Install the oil drain side bolt and tighten to **8 Nm (71 in-lb)**.
- Tighten the oil drain side bolt an additional **30 degrees**.
- Tighten the oil pressure tube side bolt to **8 Nm (71 in-lb)**.
- Tighten the oil pressure tube side bolt an additional **30 degrees**.

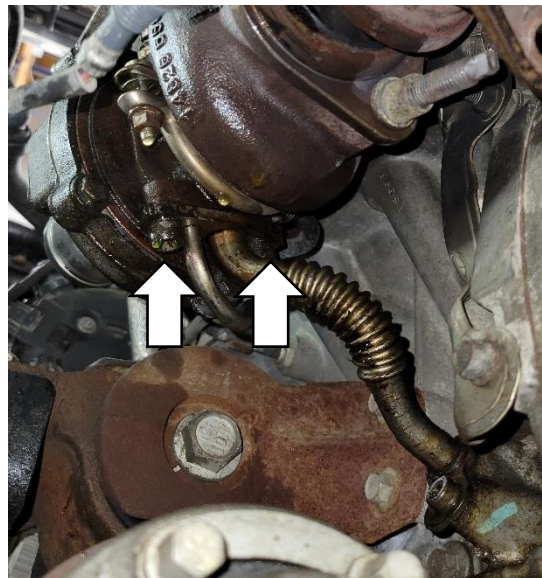

Install the oil return tube bolt at the cylinder block.

- Tighten to **10 Nm (89 in-lb)**.
- Tighten an additional **45 degrees**.

Install the oil supply tube bracket and bolt.

- Tighten to **10 Nm (89 in-lb)**.
- Tighten an additional **45 degrees**.

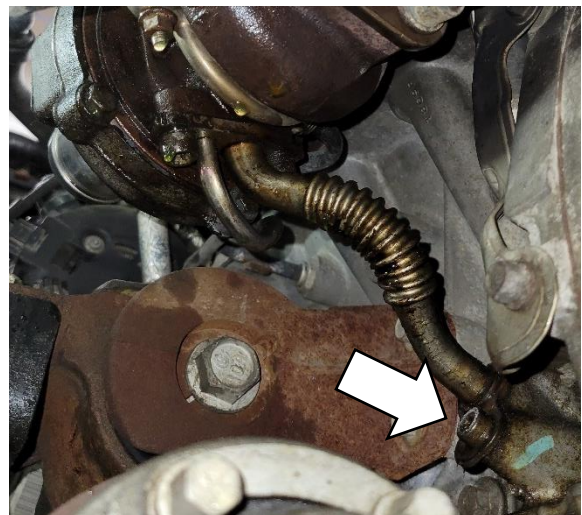

2011-2012 Turbocharger Only

Connect the 2 bypass vacuum hoses (2) and the wastegate hose (1).

Connect the bypass valve electrical connector (3).

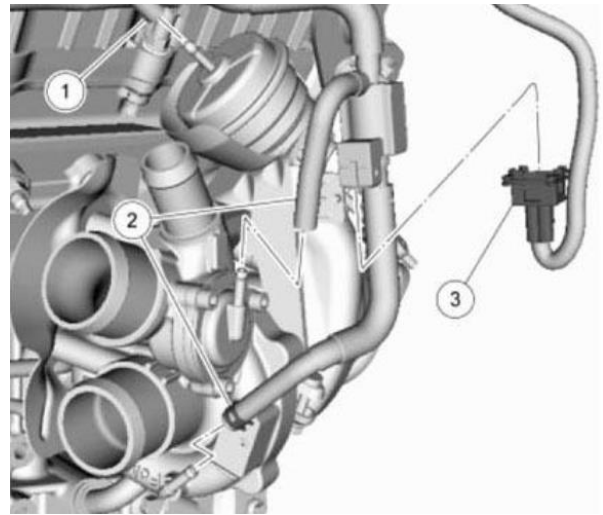

Connect the upper coolant supply tubes with retaining clips.

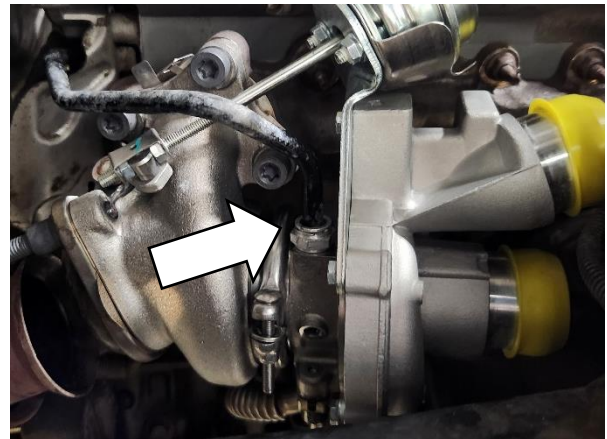

Repeat installation on opposite turbocharger

If equipped, install the exhaust system heat shield and the 2 heat shield bolts.

Torque to **20 Nm (177 in-lb)**.

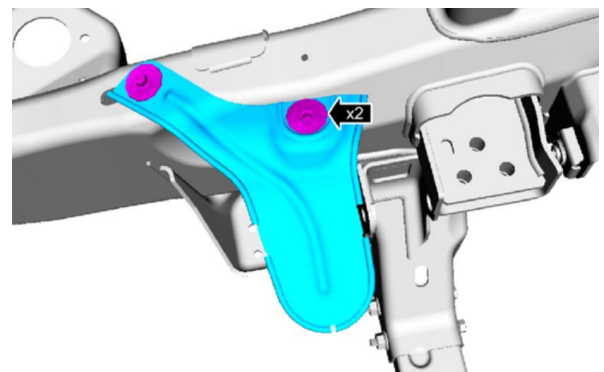

Reinstall the starter and trans cooler line support into the transmission.

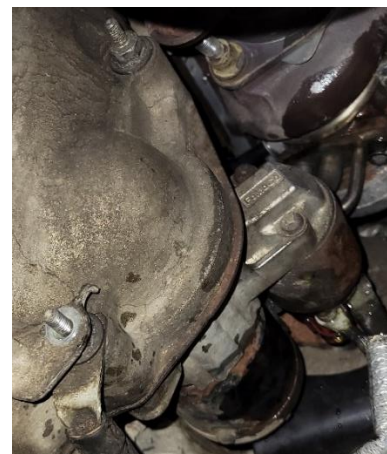

Slide exhaust forward into position.

Loosely install the turbocharger flange to downpipe with supplied nuts. Tighten in the following sequence.

- Snug the inner nut
- Tighten the outer nut to **40 Nm (30 lb-ft)**
- Tighten the inner nut to **40 Nm (30 lb-ft)**

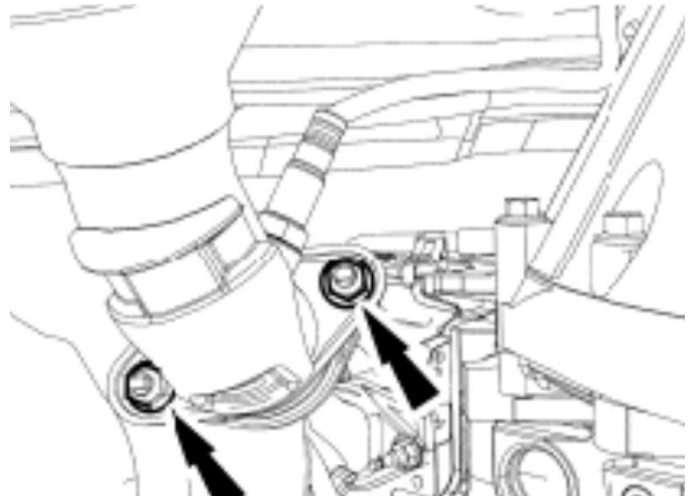

Install the RH turbo outlet pipe to the turbo and attach it to the mounting bracket.



Install the RH turbo inlet pipe to the turbo and attach it to the mounting bracket.

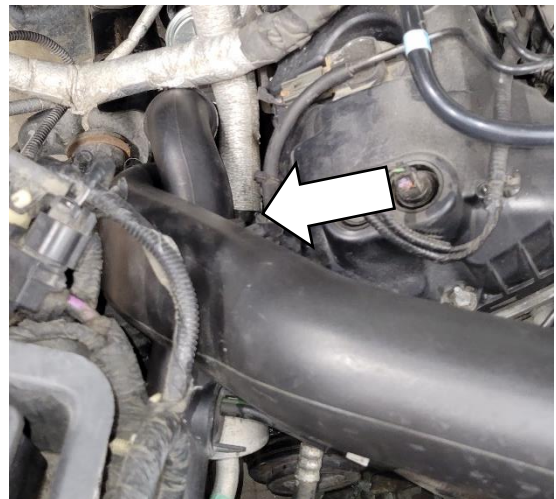

Connect the turbo inlet pipe hose to the RH inlet pipe.

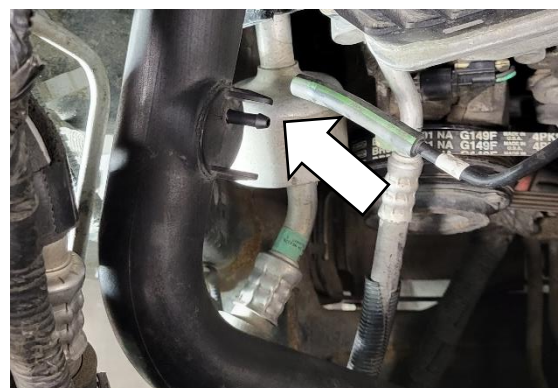

First, Lay RH turbo outlet tube into place

Secondly, install the turbo inlet tube and insert the inlet tube into the turbo inlet tube bracket grommet.

Finally, install the turbo outlet tube onto the turbo and insert it into the bracket mount.

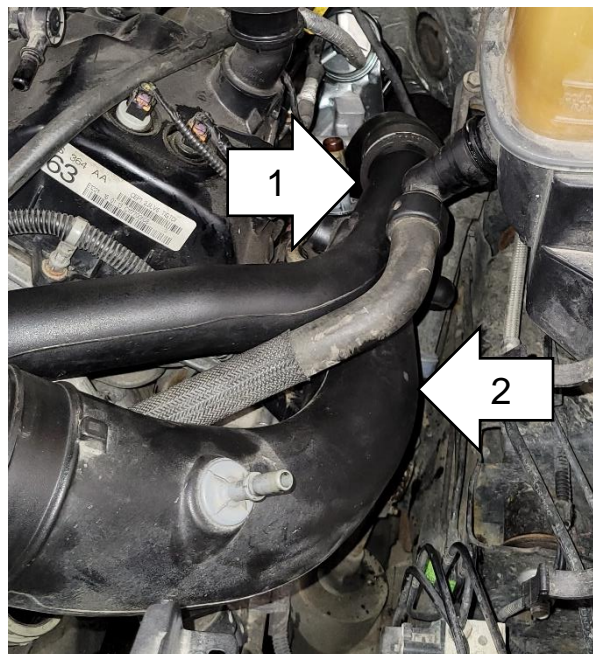

Connect the PCV pressure sensor electric connector, PCV tube quick connect couplings and install the PCV tube.



Connect the quick release couplings and the turbo bypass tube.

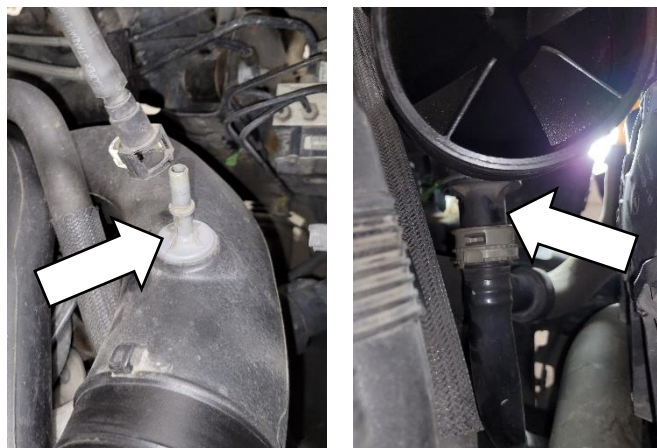

Connect CAC pipes to CAC. Tighten clamps at CAC and Turbos. Install CAC pipe from CAC to intake manifold and tighten. Connect boost sensor to harness.

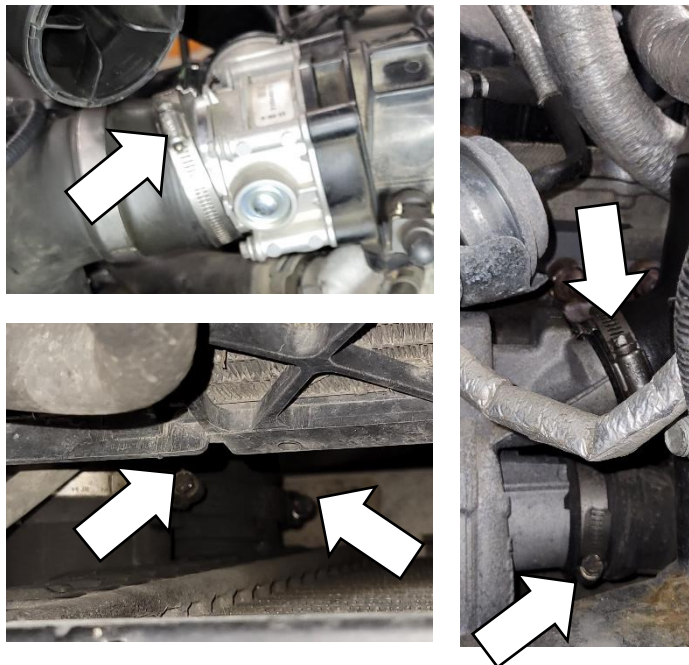

Install the Upper Air Cleaner lid and Y-Pipe to the turbo inlet pipes. Tighten all intake connections. Connect MAF sensor to harness.

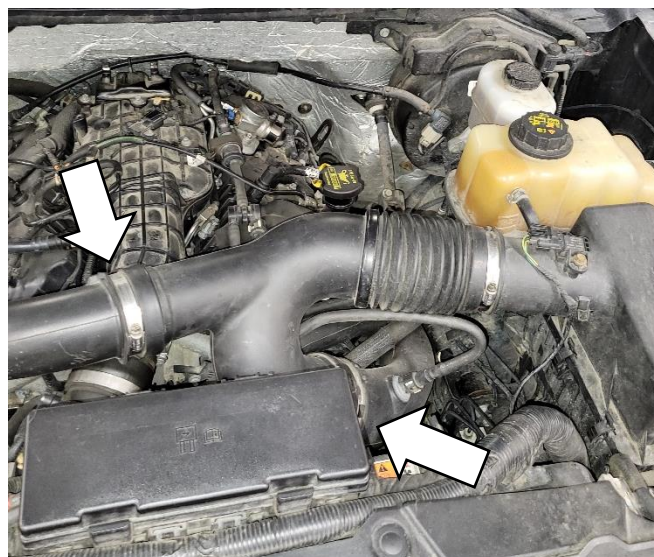

Fill the engine cooling system and connect the vehicle battery.

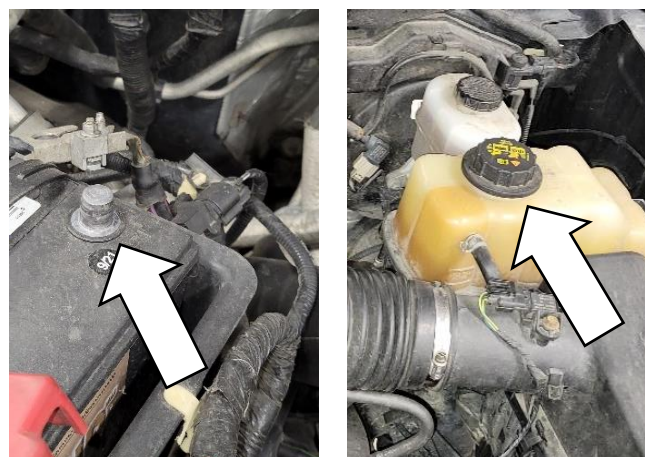

Reinstall fender liners and wheels.



Reinstall the splash shield and skid plate.

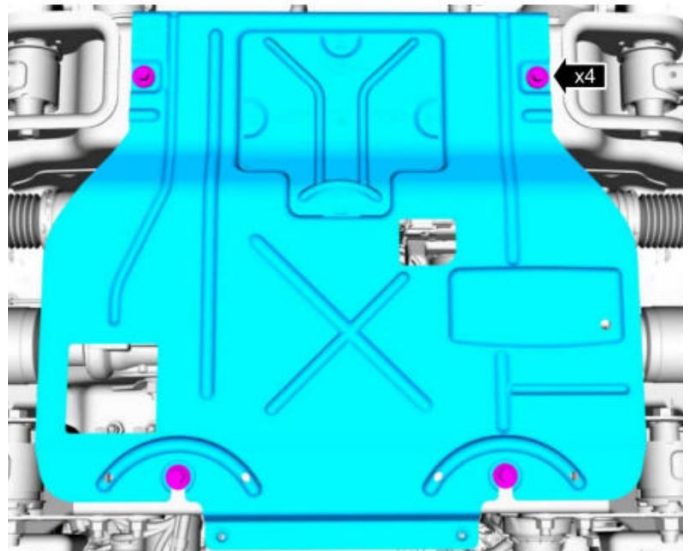
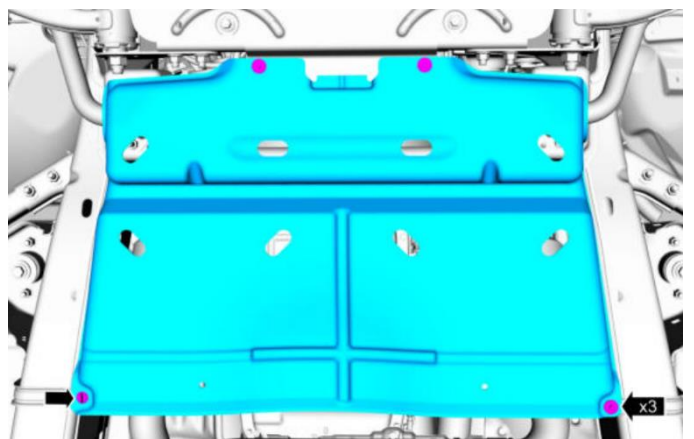

Start and idle to let the oil pressure build. Warm up to normal operating temperature and check for leaks. Road test and recheck for leaks.

Installation is complete.

EO Decal Installation (California Customers)

Install the supplied CARB EO decal under the hood next to the vehicles emission sticker as shown in the graphic.

