



**DOWNLOAD THE LATEST
INSTALL MANUALS AT
www.bddiesel.com**









**2003-2004 1/2 Dodge Lift Pump Kit
Installation Instructions
165 GPH – 15 psi**



2003-2004.5	1050335
--------------------	----------------

PLEASE READ ALL INSTRUCTIONS CAREFULLY BEFORE INSTALLATION



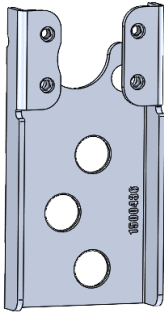

Kit Contents

1500431-15	1500310-D	1500311
		
<p>Venom Lift Pump; Assembled Qty: 1</p>	<p>Wiring Harness 1998.5-2002 Dodge Qty: 1</p>	<p>-AN 8 ORB x 3/8" Barb Qty: 2</p>

1505001	1500428	1604053	1330175
			
<p>Hose Clamp Qty: 5</p>	<p>3/8" Quick Connect Male Qty: 1</p>	<p>3/8" Fuel Hose Qty: 136"</p>	<p>5/8" ID Protective Loom Qty: 112"</p>

FT-0141716	1500436	1500393	1500373
			
<p>Bolt; M6x1 - 90mm SHCS Qty: 4</p>	<p>Bracket; Pump Qty: 1</p>	<p>Mount Strap 23.5" Qty: 2</p>	<p>Frame Bracket; 3.25" Qty: 1</p>

1500356	1300529	1300131
		
<p>Vibration Isolator Qty: 3</p>	<p>Self-Tapping Screw Qty: 1</p>	<p>Tie Wrap Qty: 12</p>

1900015	1402609	1500359	1500357
			
<i>Flange M8 x 30mm Bolt</i>	<i>M8 Flat Washer</i>	<i>Self-Threading 3/8" Bolt</i>	<i>3/8" Flat Washer</i>
Qty: 3	Qty: 3	Qty: 3	Qty: 3



1502028	1604110	1502029
		
<i>OEM Lift Pump Adapter</i>	<i>Elbow Fitting 1/4" NPT - 3/8" Barb</i>	<i>O-Ring</i>
Qty: 1	Qty: 1	Qty: 1

Table of Contents

Kit Contents 2

Table of Contents..... 3

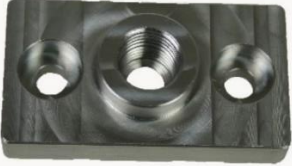
Introduction 4

Tools Required for Installation 4

Assembled Dimensions 4

Optional Accessories 5

Installation..... 6

Venom Pump Mounting 6

Mounting Option 2 - Mounting Directly to the Frame 7

Fuel Line Routing 8

Flow Specifications 12

Fuel Line Routing..... 13

Trouble Shooting 14

Update a Flowmax Pump to a Venom Pump 15

Replacement Filter Cross Reference 15

Introduction

The BD Diesel Venom fuel lift pump is a high-performance upgrade for your trucks fuel system that eliminates the factory fuel limitation. This lift pump can supply up to 165 gph of fuel, enough to support 900 horsepower.

The Venom pump is built in-house and uses ball bearings to reduce the parasitic drag within the pump allowing the pump to operate efficiently and quietly. A fuel pressure regulating diaphragm is used to improve fuel pressure regulation, allowing for more consistent fuel pressure and maximizing flow. Military grade type III hard coating is applied to the pump body to maximize durability. The Venom lift pumps are a high longevity gerotor design which results in low noise and high reliability.

Installing this kit is now easier thanks to the supplied quick connect fuel fittings which eliminate cutting the factory steel lines. This kit comes with 3/8" fuel line and fittings to connect to the factory system. See the next page for a list of optional accessories that can be used to get even more from your fuel system including 1/2" fuel line, high flow sump, and water in fuel sensor, etc.



GEROTOR DESIGN

Tools Required for Installation

Required Tools

- Knife to cut fuel hose
- 5/16", 7/16", 9/16" and 10mm sockets
- Ratchet wrench
- Flat Screwdriver
- 3/8" fuel line disconnect tool
- 5mm Allen wrench

Optional Tools

- Tape Measure
- 1/8" and 21/64" Drill Bits
- Drill
- Pliers
- 90-degree pick tool

Assembled Dimensions

Final assembled dimensions are

13.75" wide x 9" tall x 3.375" deep
(With fittings)

10" wide x 9" tall x 3.375" deep
(Without fittings)

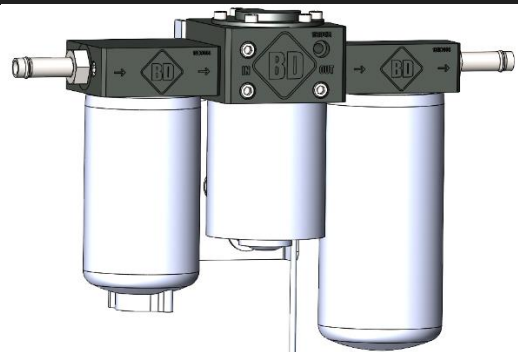

Optional Accessories

1050346 Fuel Heater Kit 12V 320W

Self-regulating 320W heater designed to prevent cold weather gelling of your fuel system with PTC heating element. Sandwiched between the water separator, pre-filter and/or the filter head.



1050330 High Flow Sump Kit

This kit installs in the bottom of the fuel tank to reduce restriction on the supply line. Kit can be installed without dropping the tank. Includes a screen to keep debris from entering the fuel line.



1050331 Monster 1/2" Line Kit

Replaces the stock 3/8" line with 1/2" all the way from the tank to the engine. Includes fittings for the Venom pump and the CP3 as well as fuel hose and clamps. Requires use of sump or draw straw kit. Bypasses stock filters.



1050350 Water in Fuel Sensor

Relocates the stock WIF sensor from the fuel bowl on the engine to the Venom water separator. Includes extension harness with built in resistor and new sensor that threads into bottom of the new filter. Use with fuel bowl deletes.



1081130 Low Fuel Pressure LED Alarm Kit

A failing lift or fuel supply pump will not only cause sub-standard performance, it can cause costly damage to the injection pump. Keep tabs on your truck's fuel system with the BD low fuel pressure LED kit, which incorporates a red or amber LED that illuminates if lift pump pressure falls below spec.



Installation

Disconnect both vehicle batteries for safety. Raise the vehicle on a hoist, or support the vehicle with jack stands for safety.

Venom Pump Mounting

Find a suitable place to mount the bracket to the frame; closest to the fuel tank. Mounting to the inside of the frame is recommended. However, mounting to the outside of the frame is required on shorter frame models due to clearance issues.

Note: Avoid mounting where the bracket could rub on fuel lines, brake lines and cables.

Note: Center hole position must be on the left.



Position the fuel pump bracket under the band straps. Orient the straps so that the threaded stud end is on the top to make tightening easier.

Start the nuts by hand and tighten the band straps until the bracket is snug. Ensure that the straps rest nicely on the bracket. Torque the band straps to **80 in-lbs**.



Insert the three vibration isolators in through the back side of the pump bracket and mount to the frame bracket using the M8 bolts and washers.

Tighten the supplied M8 bolts through each vibration isolator of the support bracket and into mounting bracket (PEM) nut.

Torque the three bolts to **12 ft-lbs**.



Once the bolts are installed, check the bracket to ensure that the bolts do not rub on any hoses/wiring.

If the bolts are in contact, gently reposition the lines/wiring to create clearance and prevent wear.

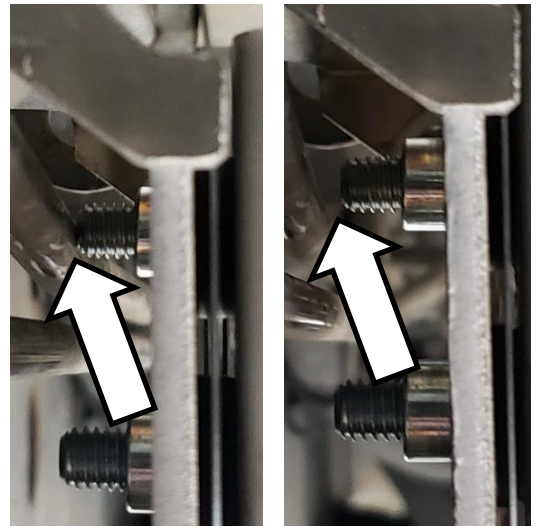

Screw in the 3/8" barb fitting onto either end of the pump.

Mount the Pump to the bracket using the four M6 bolts. Torque the four bolts to **8 ft-lbs.**



Mounting Option 2 - Mounting Directly to the Frame

Place fuel pump and bracket in place to ensure ample clearance. Then, use the fuel pump bracket as a template and mark the locations to be drilled.

Mark holes with center punch. Drill pilot holes to 1/8". Drill main holes to 21/64". Insert the three rubber isolators into the support bracket.

Place the large washers on the inside of the bracket against the rubber isolator.

Using an air ratchet with a 9/16" socket tighten the self-threading 3/8" bolt through each hole in the support bracket assembly and into the frame. Repeat this step for the other 2 bolts.

Torque the three bolts to **25 ft-lbs.**

Fuel Line Routing

Locate the stock lift pump on the side of the engine. Remove it along with the fuel line. The pump is supported by four, 5mm socket cap screws. Position a drain pan below to catch any spills.

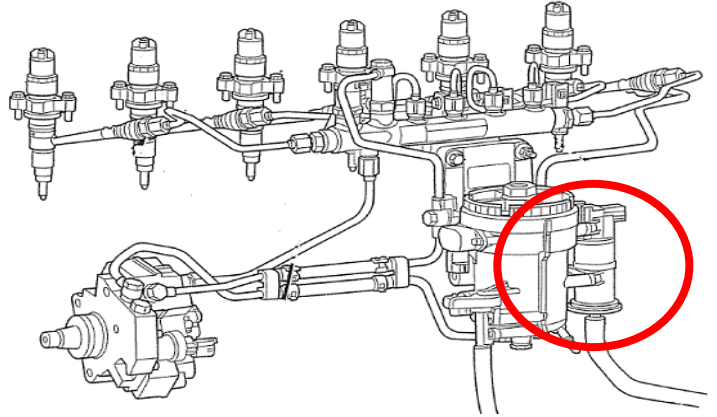

Install the brass 90° NPT to barb fitting into the supplied aluminum pump bypass bracket.

The elbow should be oriented so that the barbed end points down or 90° to the mounting holes.

Install the O-ring on the fuel filter end of the adapter.



Position and press the bypass adapter onto the fuel filter housing.

DO NOT USE MOUNTING BOLTS TO DRAW BYPASS ADAPTER IN TO THE FILTER HOUSING

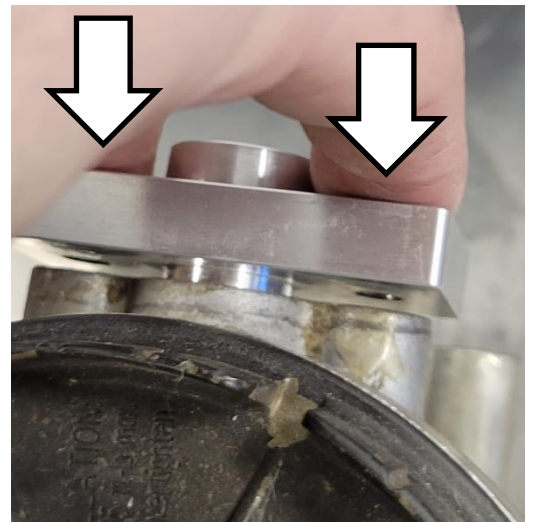

Be sure the bypass adapter is positioned flat to the fuel filter housing. Install mounting bolts and evenly tighten to **61 in-lbs**.

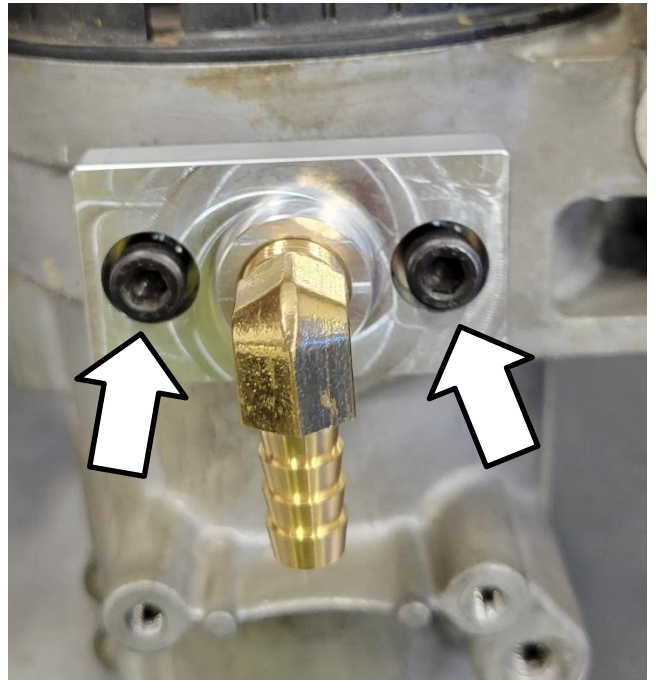

Prior to install in the truck, wrap the fuel line in the provided 3/4" loom.



Route the 3/8" Fuel hose along the frame rail down to the approximate mounting location of the Venom pump.

DO NOT CUT HOSE AT THIS TIME.



Slide the 3/8" Fuel hose onto the barbed end of the 90° fitting and tighten using a hose clamp.

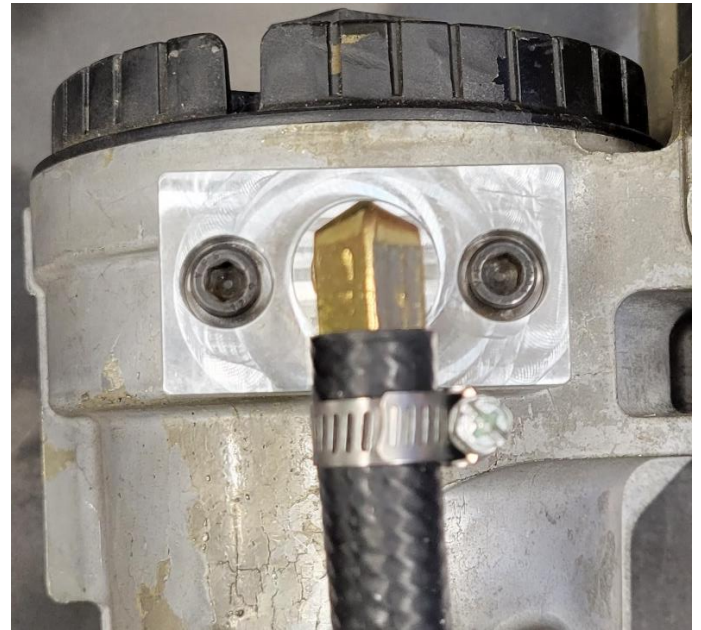

With the other end of the hose connected, cut the hose to length at the lift pump.

Connect the newly cut end of the hose to the 3/8" hose barb installed in the Venom pump using a hose clamp.



Install one end of the hose on the 3/8" hose barb using a hose clamp. Install the 3/8" quick connect fitting into the other end of the hose using a hose clamp to prepare for install onto the tank.

Fish the other end of the hose over the top of the fuel tank alongside the frame to the fuel tank module.



Locate the factory quick connect fuel supply line (as indicated) and remove the factory quick connect fitting.

Connect the supplied 3/8" quick connect fitting attached to the venom fuel line to the tank module supply line.

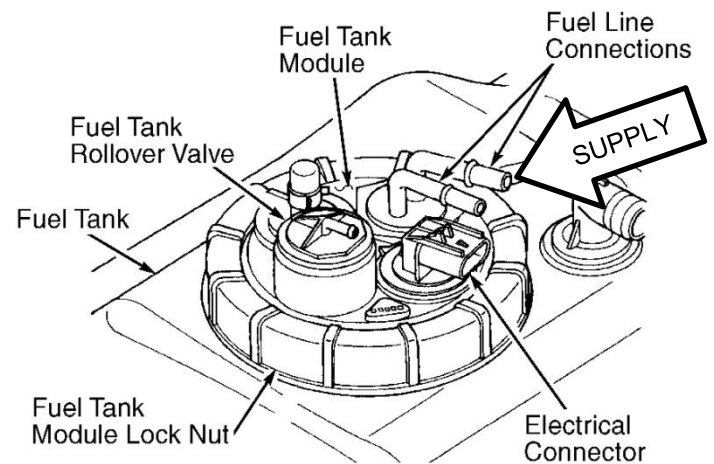

Lay out the wiring harness so that it can be plugged into the stock fuel pump harness, plug into the new Venom Fuel Pump, and place the positive and negative terminals in their approximate routing.

Once the routing paths have been chosen and laid out, install the relay to the firewall with the use of the self-tapping screw.



Wiring should be attached with the use of supplied tie wraps so that the wiring will be away from contacting hot surfaces and/or moving components.

Once the wiring is attached and everything is in place the positive and negative terminals can be attached to the battery.



All of the fuel line routing should be complete. Make certain that all fuel lines and wiring harness' are fixed in place. Check the lines are adequately supported. Ensure no fuel hose or wiring is exposed to possible chafing.

To help with priming the lift pump, fill each filter with diesel and install onto the pump.



Installation of kit should now be complete. Reconnect the batteries and test the pump for operation.

With everything reconnected, cycle the ignition to "ON" several times before attempting to start the vehicle. This primes the fuel pump, which will purge some air out of the system. Once cycled several times, the system will be primed and the vehicle can be started. With the key in the on position, you should hear the pump running.

Start the vehicle and allow it to run for several minutes and check for leaks at all connections.

If the pump motor does not run or there is a pressure or supply issue, refer to the end of the manual for troubleshooting.

Flow Specifications

- Flowrate should be MINIMUM 2.75 GPM (165GPH) @ 14VDC

OR

- Filling a 1-gallon container every 22 seconds @ 14VDC
- Expected Idle pressure 15 - 18 psi
- Minimum 8 psi @ Wide open throttle

Fuel Line Routing

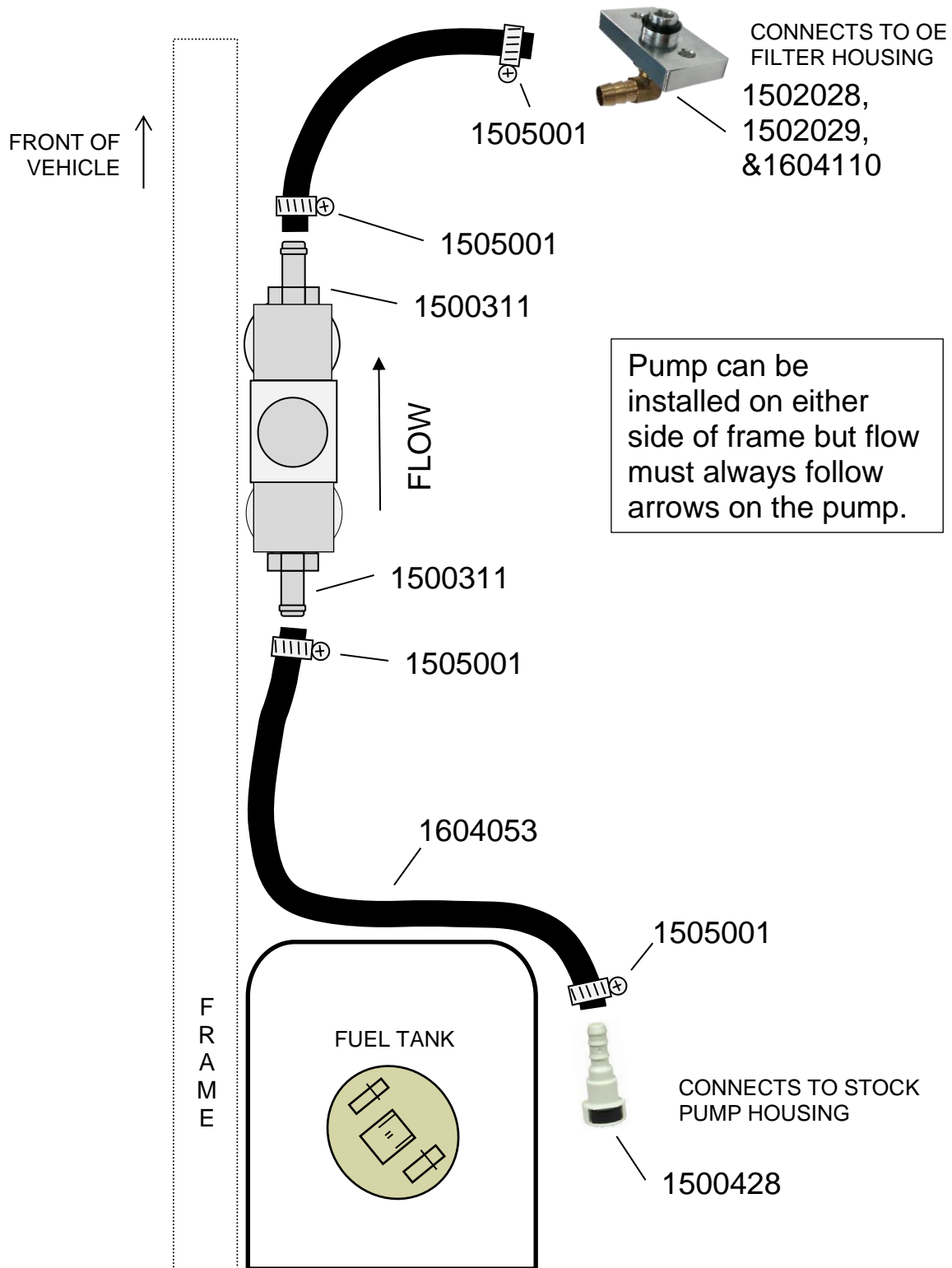

Trouble Shooting

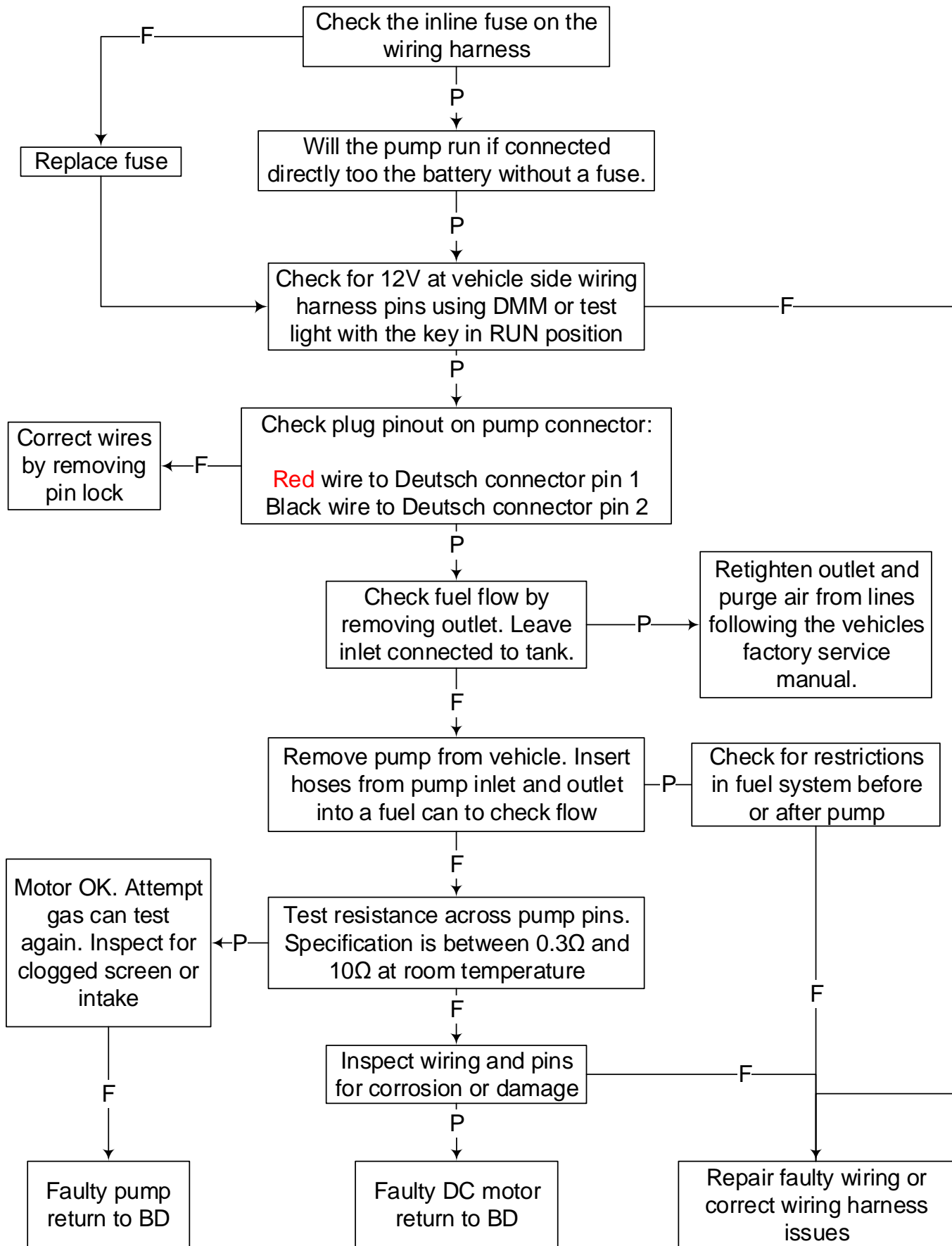

Update a Flowmax Pump to a Venom Pump



Replacement Filter Cross Reference

The Venom Lift Pump kit is supplied with a water separator and fuel filter combo. The replacement filter parts through BD are listed below with equivalents.

Water Separator		Fuel Filter	
BD Diesel	P550550-VEN	BD Diesel	P551315-VEN
Donaldson	P550550	Donaldson	P551315
Baldwin	BF1275	Baldwin	BF7634
WIX	33616	WIX	33626
Luber-Finer	LFF9594	Luber-Finer	LFF4783

Replacement Center Section

If the center section needs to be replaced, a **1500430-15** may be ordered as a replacement. Contact BD Diesel for more details.

