



**DOWNLOAD THE LATEST  
INSTALL MANUALS AT  
[www.bddiesel.com](http://www.bddiesel.com)**



## **GMC Duramax (LB7) High Idle Kit**

Note: Only for vehicles with cruise control



1036600





2001-2004 GMC Duramax

**PLEASE READ ALL INSTRUCTIONS BEFORE INSTALLATION**

## KIT CONTENTS

Please check to make sure that you have all the parts listed in this kit before you start.

<b>1036600 High Idle Kit</b>	
	<p><b>12084912</b></p> 
<p><i>Wiring Harness</i></p> <p><b>Qty: 1</b></p>	<p><i>Spare LB7 ECM Terminal</i></p> <p><b>Qty: 1</b></p>

<p><b>1330155</b></p> 	<p><b>1300131</b></p>  <p><i>Medium Tie Wrap</i></p> <p><b>Qty: 6</b></p>	
<p><i>1/4" Loom</i></p> <p><b>Qty: 90"</b></p>	<p><b>1300337</b></p> 	<p><b>1003332</b></p> 
	<p><i>Mini Fuse Tapper</i></p> <p><b>Qty: 1</b></p>	<p><i>Switch Decal</i></p> <p><b>Qty: 1</b></p>

## Tools Required

- Drill with stepper drill bit
- Utility Knife
- Small flat screwdriver or pick
- 7mm & 10mm Sockets
- Ratchet with extension

## Introduction

This high idle kit allows the operator to enable the high idle programming within the Duramax ECM. In conjunction with the cruise control switches, the operator may select different RPMs for fast idle.

This kit is perfect for faster warm ups, extended idling and PTO applications.

## INSTALLATION



**VEHICLE SHOULD BE SAFELY SECURED BEFORE INSTALLATION.**

Disconnect both batteries for safety.

Remove trim surrounding instrument cluster by gently pulling out the clips. This may be eased by tilting the steering wheel downwards and moving the shift lever from park to 1<sup>st</sup>.



Remove fuse cover from end of dash. Remove knee bolster by removing the two 7mm screws along bottom edge, and then pull knee bolster outwards. Use care not to damage the clips.

Position toggle switch near the desired location keeping sufficient wire slack. Feed the wires below the dash.



### 2001-2002 Model Fuse Panel

Remove the cruise control fuse from the in cabin fuse panel and install fuse tapper. Reinstall fuse with tapper on the right side of the fuse.

(towards the rear of the vehicle)

#### Cruise Control Fuse

2001-2002 Fuse #6 – 10A

2003-2004 Fuse #9 – 10A

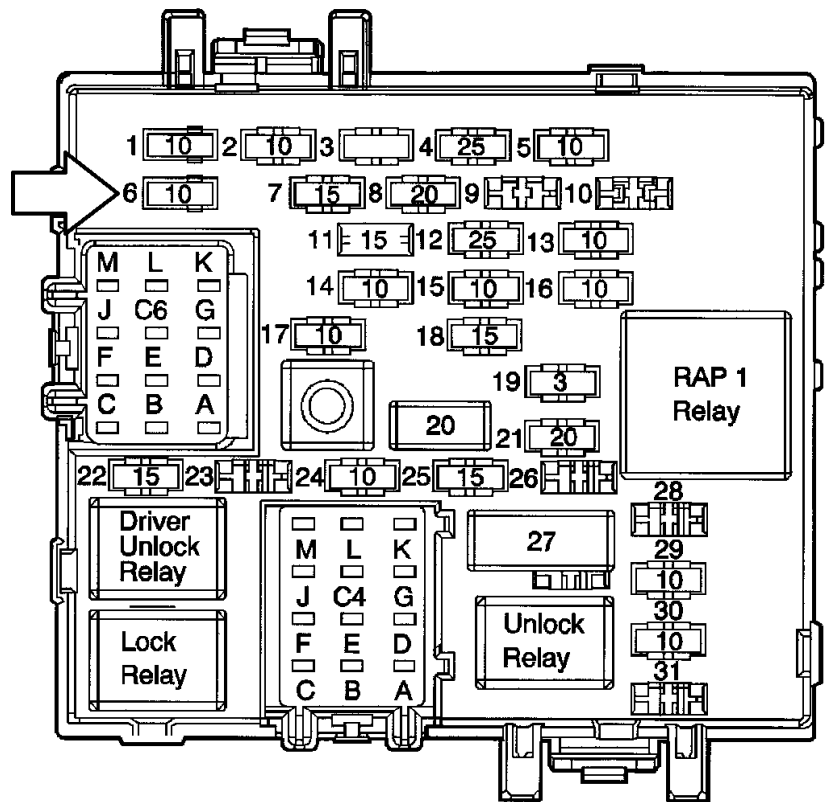

### 2003-2004 Model Fuse Panel

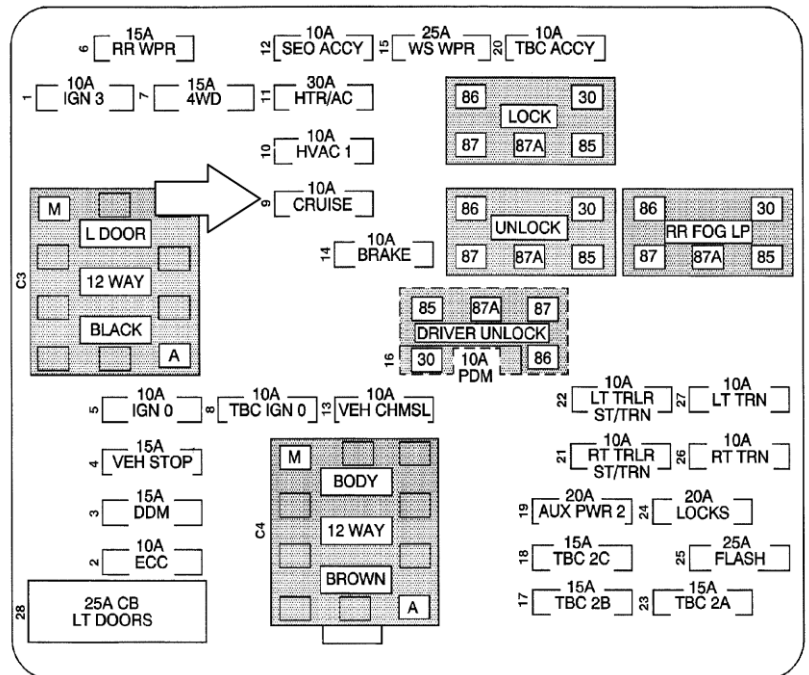



Route the red wire to the fuse box and connect to the fuse tapper

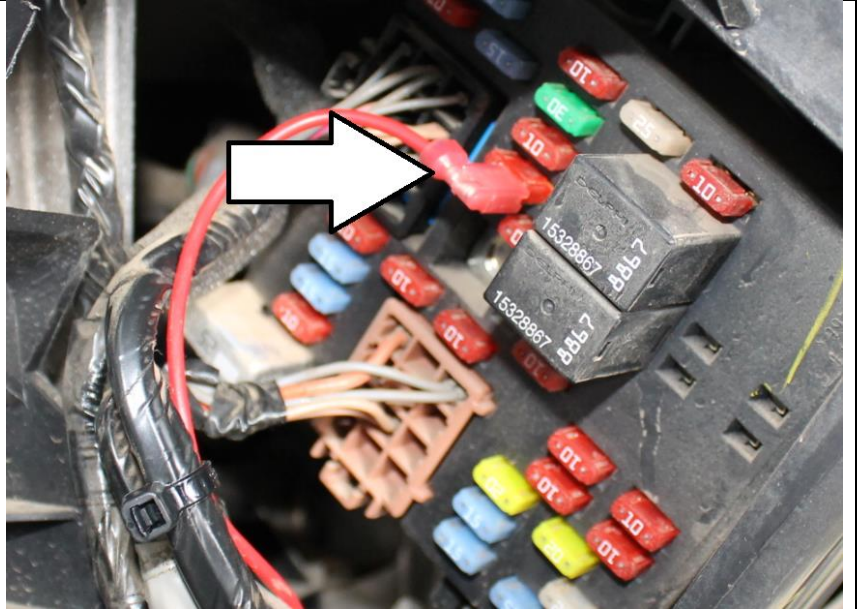
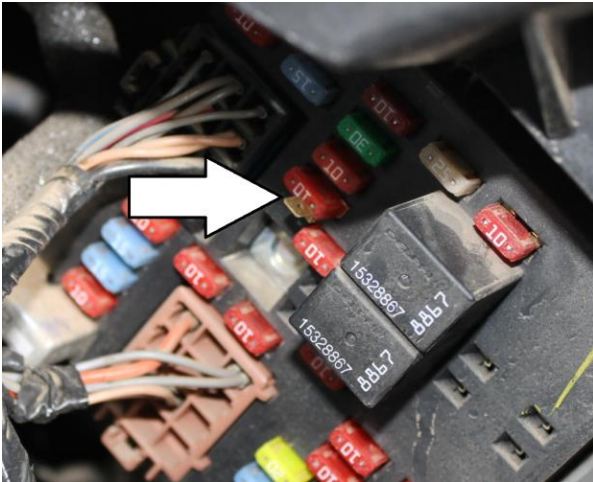

Route the black wire to the head of a bolt below the dash to serve as a ground. Remove the bolt using a 10mm socket and ratchet, install ring terminal and reinstall the bolt.

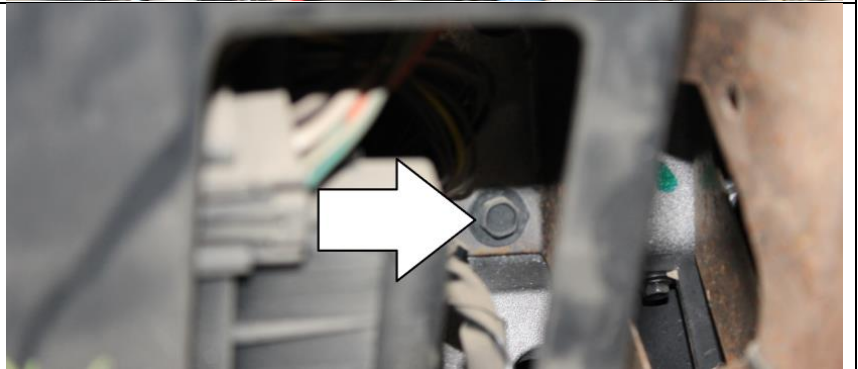

Locate suitable pass through location on firewall. Suggested location is alongside the smaller wiring harness passing through the firewall, this is located towards the passenger side of the brake booster assembly. Cut a small slit in the rubber boot using a utility knife for the wire to pass through. Alternatively, if other wires are already fed through the main wiring harness connector below the brake booster, this route may be used instead. Feed the yellow wire from the switch through the firewall. Use care not to damage the pin while being pushed or fished through the rubber grommet as it is fragile. If the grommet being utilized is tight, do not damage the pin, either enlarge the hole or cut the wire and rejoin it afterwards.

Locate the ECM on the driver's side of the engine bay beside the battery.

Remove the plastic cover from the ECM.

**Note:** Removing the TCM first may make this process easier.

Once the ECM is exposed, release the metal clip holding the ECM in place so that it may be rotated for better access to the connectors.

With the ECM positioned so that you can see the electrical connectors, locate the connector identification information cast into the ECM housing.

There are two electrical connectors designated C1 and C2. Locate "C1/BLUE".

Unscrew the bolt securing C1 to the ECM.

Once the connector is off, remove the plastic pin retainer by releasing the two clips on either side of it.

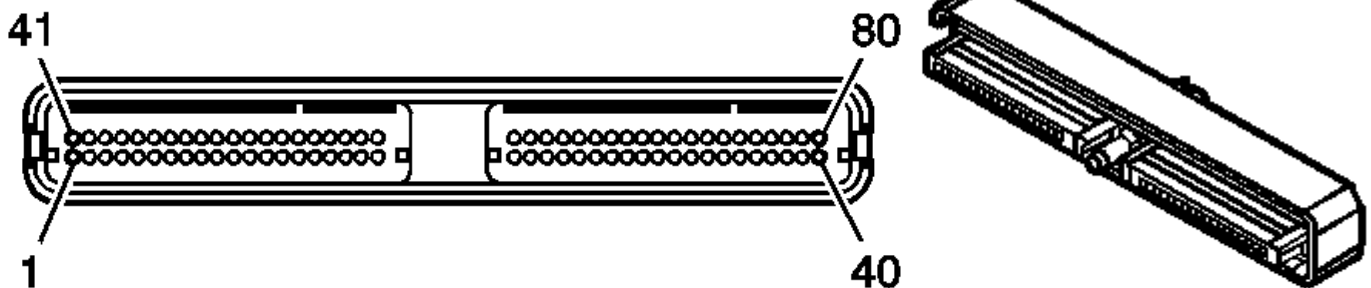
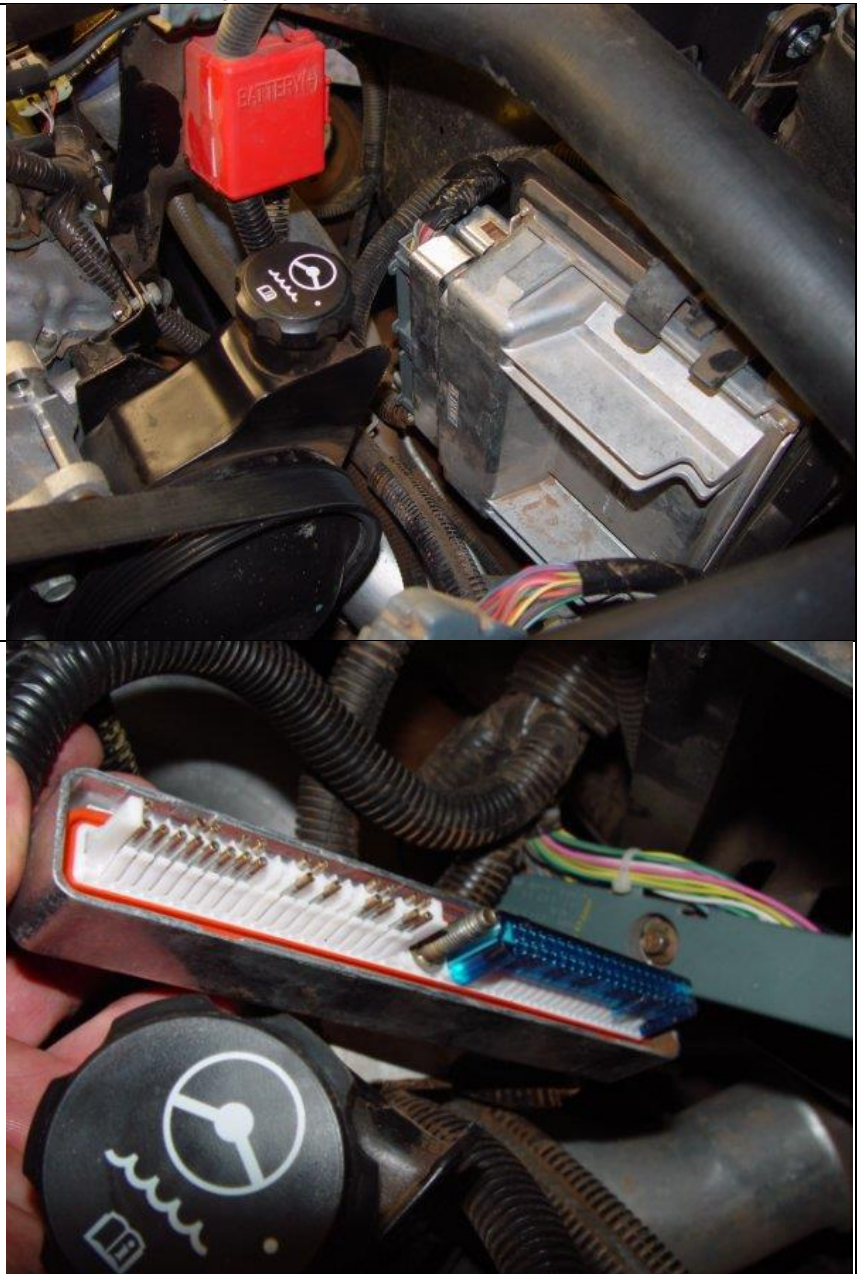



Turn the connector over, and on the back side locate pin location 71 on the C1 connector. The existing rubber seal on the back side will need to be pierced to insert the new wire. Do this with a pick or sharp tool.

Insert the yellow wire from the BD high idle kit into pin 71.

Lightly tug on the wire to ensure it is fully seated in the connector, then reinstall the plastic pin retainer.

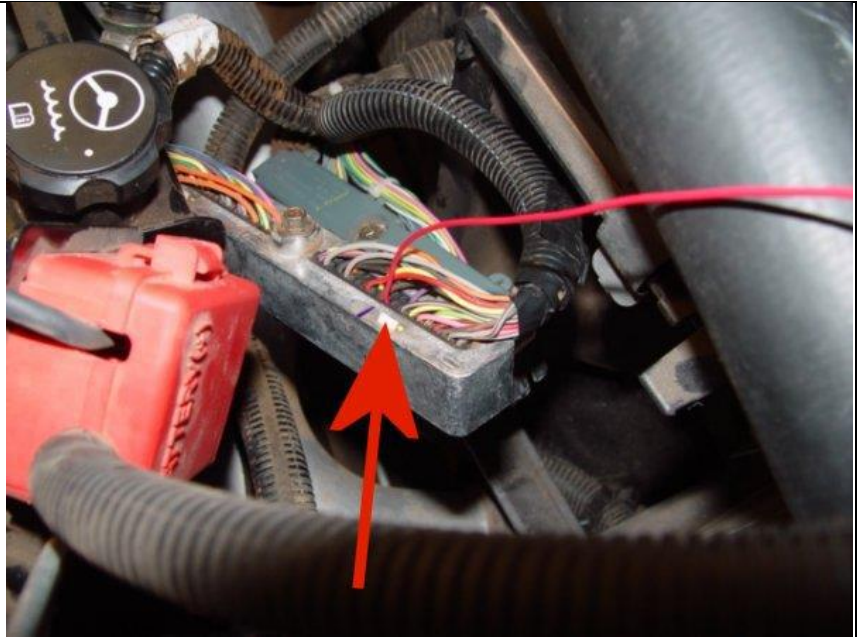

One spare terminal has been supplied with this kit incase the terminal is damaged during installation. Discard if not needed. (PN:12084912)

Reinstall the connector in the ECM and reinstall the ECM retainer clip and dust cover.

Install supplied wire loom over the high idle kit wire from the ECM to the firewall. Secure with supplied tie wraps at the connector to reduce strain on the wire.

Using remaining wire loom, cover the under dash wiring and secure it out of the way.

Drill hole in desired dash panel for switch using stepper bit. Ensure chosen location has sufficient room behind it for the switch body.

Reinstall knee bolster, fuse panel cover, and bezel surrounding the instrument cluster. Install switch through hole.



Reconnect vehicle batteries. Test for correct operation.

## Operation

The 2001-2004 Duramax has two or three high idle speeds available, 800 rpm, 1200 rpm and 1800 rpm. To operate the high idle, the engine must be running, transmission in park (or neutral for manual trans), foot off of the brake and parking brake set. Turn the toggle switch on to start high idle. The engine will now increase from its normal idle speed to 800 rpm. To access the higher speeds, turn on the cruise control and press either SET or RESUME/ACCELERATE. Pressing SET (button on the end of the stalk) will yield 1200 rpm, pressing RESUME (one click past the on position) will yield 1900 rpm. To stop the high idle, simply turn the toggle switch back off.



### **Do not leave the high idle switch on while driving.**

The idle speeds may be adjusted using a Tech2 factory scan tool. The above engine speeds are the default values and will suffice for normal extended idling, high idle and PTO applications.

## Special Notes

Some 2002-2004 model year trucks will only support two idle speeds – SET and RESUME. These can be altered using a GM Tech2 scan tool.

The high idle (PTO) feature is normally already enabled, however it may be necessary to enable on some vehicles using the GM Tech2 scan tool.

Some vehicles may have been manufactured with the PTO option from factory. If so, the PTO control panel connector will be located behind the airbag disable switch or behind the glovebox. A PTO accessory kit may be ordered from GM (Part #12497678).



If the truck already has the PTO accessory kit installed, it will be necessary to tap into connector C106 by the under hood fuse box. Connect the green wire (Pin C) from the male side of C106 to the PCM at C1 pin 71.

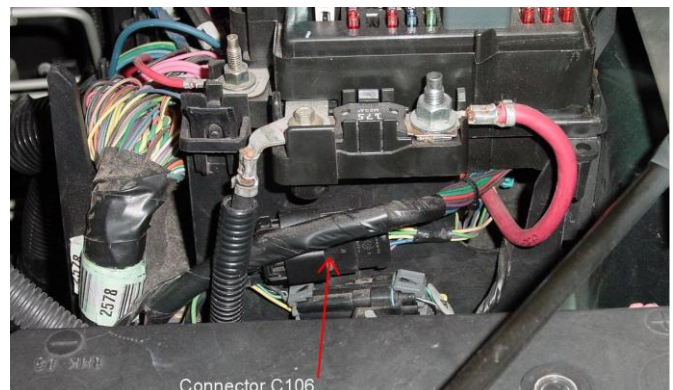



**Troubleshooting**

**Toggle Switch Not Illuminated When On**

Using test light, verify the fuse that has been tapped has switched ignition power.

Check ground ring terminal connection.

Verify toggle switch wiring is correct.

Toggle switch lamp burnt out.

**High Idle Does not Function**

Ensure toggle switch is lit, indicating it is powered.

Ensure the pin inserted into the ECM is fully inserted and has not backed out.

Ensure brake lights are operating normally and brake pedal is not pressed.

Ensure parking brake light in the instrument cluster is on when parking brake pressed, indicating the park brake switch works.

Ensure PRNDL display does show P when transmission is in park.

Check that the PTO function is enabled and speeds are correct using a Tech2 scan tool

