

<THESE INSTRUCTIONS MUST BE GIVEN TO THE END USER>



B&W Trailer Hitches
 1216 Hawaii Rd / PO Box 186
 Humboldt, KS 66748
 P:800.248.6564
 F:620.869.9031

Call or Email us for
 Installation Support
 hitches@turnoverball.com
 bwtrailerhitches.com

Custom 5th Wheel Hitch Mounting Rail Installation Instructions

MODEL 2602

See Limited Lifetime Warranty at
bwtrailerhitches.com/warranty

2014-2024 RAM 2500 Trucks

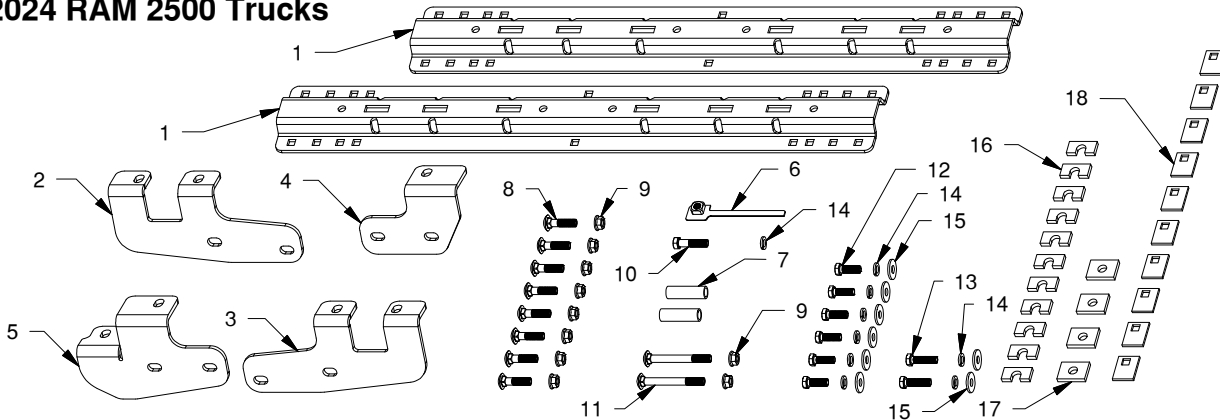

Patriot Rail Box (RVR3210)		
ITEM	DESCRIPTION	QTY
1	Mounting Rail	2

Bracket Set Box (RVR2602)		
ITEM	DESCRIPTION	QTY
2	Passenger Side Front Bracket	1
3	Driver Side Front Bracket	1
4	Passenger Side Rear Bracket	1
5	Driver Side Rear Bracket	1
6	Nut Guide	1

Bracket Set Bolt Bag #1		
ITEM	DESCRIPTION	QTY
7	Tube Spacer	2
8	1/2" X 2" Carriage Bolt	8
9	1/2" Flange Nut	10
10	1/2" X 2" Hex Head Bolt	1
11	1/2" X 4-1/2" Carriage Bolt	2
12	M12 X 35mm Hex Head Bolt	6
13	M12 X 45mm Hex Head Bolt	2
14	1/2" Split Lockwasher	9
15	1/2" Flat Washer	8

Bracket Set Bolt Bag #2		
ITEM	DESCRIPTION	QTY
16	5/16" U-Shaped Spacer	11
17	Round Hole Rectangle Washer	4
18	Offset Square Hole Washer	10

⚠ WARNING Failure to comply with the safety information in these instructions could result in serious injury or death.

- ⚠** Read all installation and operating instructions along with all labels before using this product.
- ⚠** Adding components to the chassis of any vehicle can be hazardous. There is potential for damage to vehicle, injury from tool usage and many other hazards. This installation must be completed by someone who is aware of the hazards involved. This person must be knowledgeable of proper safety procedures for a vehicle installation of this nature, and for usage of the equipment required to perform the installation.
- ⚠** Without proper knowledge, towing can be a dangerous activity. Understand all the risks involved with towing before proceeding. For information on towing safety, see **"The Trailer Handbook: A guide to Understanding Trailer and Towing Safety"** from the *National Association of Trailer Manufacturers*, www.NATM.com and your trailer manufacturer's owner's manual.
- ⚠** Do not exceed tow or tongue rating of coupler, tow or tongue rating of hitch, or tow or weight ratings of truck or trailer. See vehicle and trailer manufacturer information for ratings. Exceeding these ratings may cause damage to towing components or loss of attachment between the trailer and truck.
- ⚠** Additional caution must be used when towing a wedge car trailer. Towing stability greatly depends on keeping the center of gravity as low as possible. Load heavy cars over the axles. Never tow with a single car on the front of the trailer. When towing a wedge car trailer, never exceed speeds that are reasonable for the roadway conditions (e.g. turns, going around a curve, etc.). Failure to account for proper trailer center of gravity and speeds that are reasonable for the roadway conditions may cause damage to the truck, trailer, towing components, and loss of attachment between the truck and trailer.
- ⚠** Do not modify this product in any manner. Doing so could alter its integrity and lead to a loss of attachment between the trailer and the tow vehicle.
- ⚠** A visual inspection of the hitch should be performed before each time you tow. Regularly check that all pinned connections are secure, and that all bolted connections are at the correct torque specification. Check for cracks or damage to the hitch. Do not tow with the hitch if cracks or damage outside of normal wear is found. Towing with a hitch that has cracks or damage could result in damage to the tow vehicle, trailer, towing components and loss of attachment between the tow vehicle and trailer.

PREPARING TO INSTALL

NOTICE: It may be necessary to remove the spare tire and/or heat shield before installation.

NOTICE: If truck is equipped with a removable bed liner or mat, it should be removed or it must be cut to allow the mounting rails to connect directly with the bed. It is acceptable to install the mounting rails over a spray in bed liner.

NOTE: Remove all parts from the packaging and familiarize yourself with all the parts and tools required. Use the parts list on the front page to verify that all parts and hardware are present.

⚠ WARNING: Do not install frame brackets over wiring or brake lines. Always place the hitch components directly against the frame of the truck. Failure to move such components can lead to property damage or serious injury.

Installation of the mounting rails requires several common tools and a few specialized tools. Below is a listing of equipment used during a typical installation.

- Impact Wrench or Ratchet with 3/4" and 19mm Sockets
- 3/4" and 19mm Box End Wrenches
- A Drill and 1/8", 9/16", and 7/8" Drill Bits
- Patriot 5th Wheel or Slider Base
- Hammer
- Flashlight
- Tape Measure
- Eye and Ear Protection
- Torque Wrench
- Center Punch Tool
- Spray Lubricant or Compressed Air

IMPORTANT: A variation between truck models requires a different installation procedure for the rear mounting rail. Look at the exhaust hanger bracket below the bed on the inside of the passenger side frame behind the suspension spring. A piece of round bar may be present inside the exhaust hanger bracket that limits access to the area. When installing the rear mounting rail, if the bar is present follow the "Install Rear Mounting Rail 2019+ Trucks" section. If not present, follow the "Install Rear Mounting Rail 2014-2018 Trucks" section. See Figure A1 for reference.

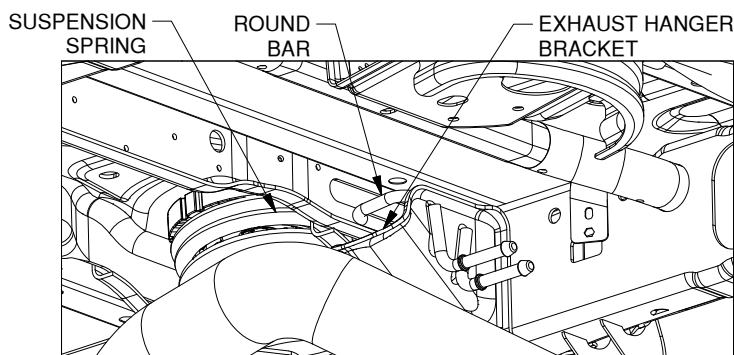

Figure A1: View looking up at the inside of passenger side frame.

DRILL FORWARD MOUNTING HOLES

- 1. Layout the forward mounting rail.** Place a mounting rail onto the bed of the truck. Hook a tape measure over the rear edge of the bed (not on any part of the tailgate), measure the location for the mounting rail, as shown in Figure A2. Next, center the mounting rail in the bed by measuring the distance on either side from the edge of the rail to the sides of the bed. The rail will be centered when both measurements on either side of the rail are the same.

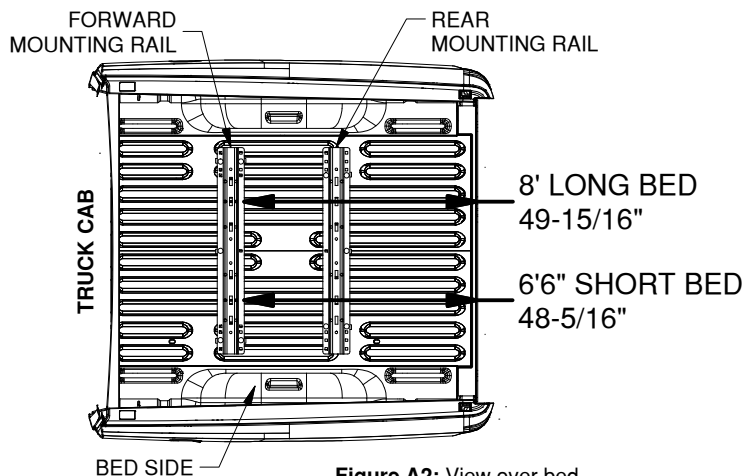

Figure A2: View over bed.

IMPORTANT: The mounting rail is designed to install only at the described location. Failure to place the mounting rail precisely may result in added difficulty during installation and/or property damage.

- 2. Mark hole locations.** While carefully ensuring the mounting rail does not move, use a center punch tool to mark the 5 drill locations on the forward rail. See Figure A3 for hole marking locations for this installation (rear rails will install on a later step). Once all 5 forward rail locations are clearly marked, move the mounting rail out of the way and drill each location with an 1/8" drill bit.

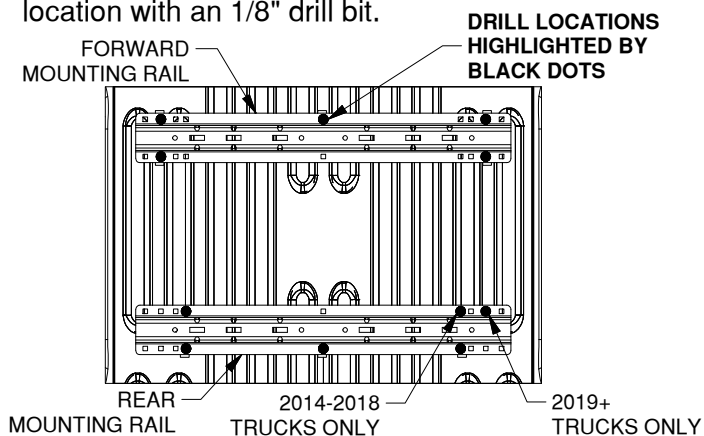

Figure A3: Detail view over bed, showing drill locations for the forward and rear mounting rails.

⚠ WARNING: The fuel tank of the truck may be directly below the area of the bed which needs to be drilled. Always carefully examine the area under the truck where modification will occur. Make certain that the tank, or other equipment, is not damaged during drilling. Damage to the tank may result in property damage, serious injury or death.

- 3. Check hole locations.** Locate the driver side front bracket. Position and hold the bracket flat against the inside of the frame where it will be installed, see Figure A4. Check that the 1/8" pilot holes are centered within the slots in the frame brackets. If the 1/8" drilled holes are not centered within the slots, re-drill the 1/8" holes until the brackets and the drilled holes are aligned. Repeat the process for the passenger side using the passenger side front bracket, see Figure A5.

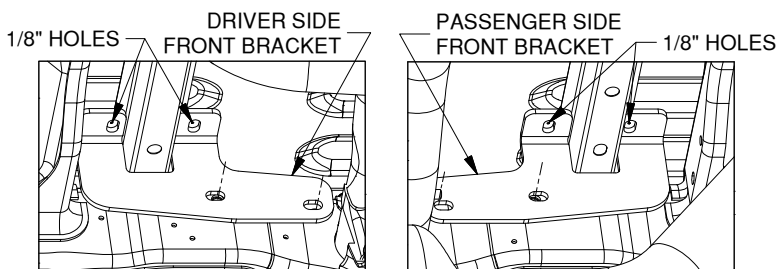

Figure A4: View looking up at the inside of driver side frame.

Figure A5: View looking up at the inside of passenger side frame.

- 4. Enlarge the holes.** On top of the bed, using the 1/8" holes as pilots, drill out each hole with a 9/16" bit.

INSTALL FORWARD MOUNTING RAIL

NOTICE: Due to the corrugation of the truck bed, U-shaped spacers are provided to function as space fillers between the mounting rails and the kit attachment hardware. Always place a U-shaped spacer in the gap either above the bed (between the mounting rail and the bed) or below the bed (between the bed and the side frame brackets). Failure to use U-shaped spacers will result in property damage when hardware is tightened.

- 1. Position the forward mounting rail.** Re-position the forward mounting rail over the drilled 9/16" holes in the bed. Place a 1/2" x 2" carriage bolt through the mounting rail and into each of the 5 drilled locations. Place a U-shaped spacer between the bed and the mounting rail at the five drilled positions, see Figure B1.

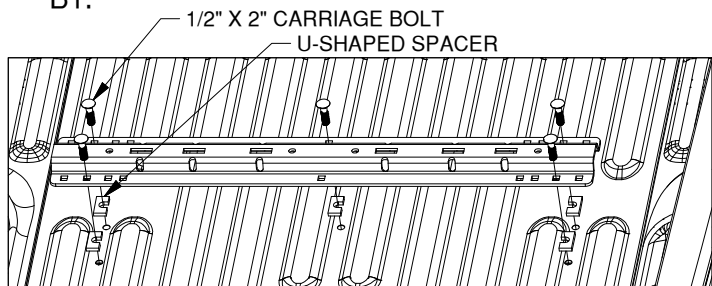

Figure B1: View looking into truck bed from rear of truck.

- 2. Clean the mounting locations.** Each bracket will fasten to the frame using pre-existing weld nuts. Before attaching hardware, debris must be cleaned out of each weld nut. Use spray lubricant or compressed air in each mounting location to remove loose dirt. If larger debris is present use of a small wire brush may be required.

- 3. Install the front brackets.** Locate the two front brackets, four round hole rectangle washers, two M12 x 45mm hex head bolts (longer), two M12 x 35mm hex head bolts (shorter), four 1/2" split lock washers, and four 1/2" flat washers. Due to curvature of the frame the forward hole in each front bracket will need to be supported with two round hole rectangle washers. See Figure B2. Using a 1/2" lock washer and 1/2" flat washer, thread the longer (45mm) M12 hex head bolt into the frame through the forward holes in the brackets and through both round hole rectangle washers. Again, using a 1/2" lock washer and 1/2" flat washer, thread the shorter (35mm) M12 hex head bolt into the frame through the remaining holes. See Figures B3 and B4. Do not fully tighten at this time.

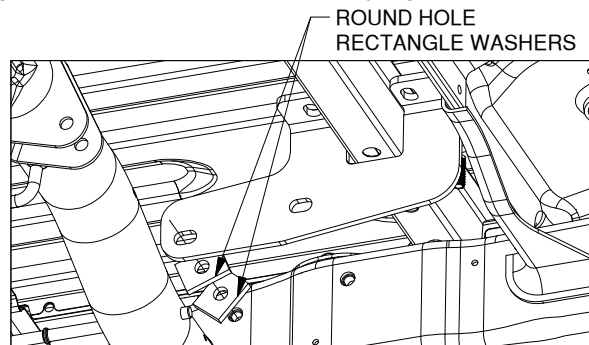

Figure B2: View looking up at passenger side frame.

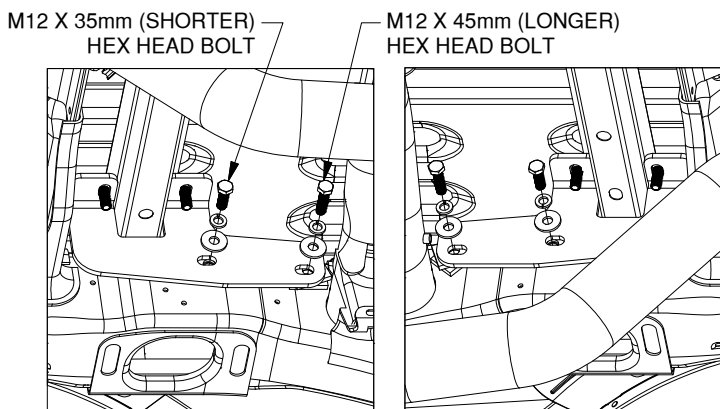

Figure B3: View looking up at driver side frame.

Figure B4: View looking up at passenger side frame.

- 4. Fasten the forward mounting rail.** Install an offset square hole washer and 1/2" flange nut on each of the carriage bolts passing down through the bed as shown in Figure B5. Do not fully tighten at this time.

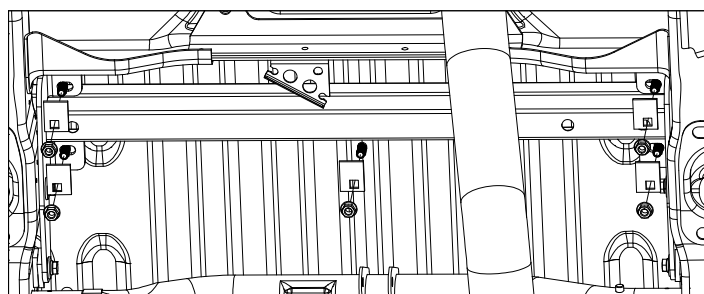

Figure B5: View looking up at bed from underneath truck.

NOTE: If installing in 2019 or newer truck, skip to "INSTALL REAR MOUNTING RAIL 2019+ TRUCKS."

INSTALL REAR MOUNTING RAIL

2014-2018 TRUCKS

1. **Position the rear mounting rail.** For this step the base which will be used in the mounting rails is required. Place a mounting rail into the truck bed behind the forward mounting rail. Place the base over the rail attachment points and carefully lower it until the pin tabs pass through the attachment points on the forward mounting rail. Attach the rear mounting rail to the rear mounting points on the base. The base should rest flat against the top of the rails, see Figure C1. With the base still attached, ensure that the rear rail is centered in the truck bed.

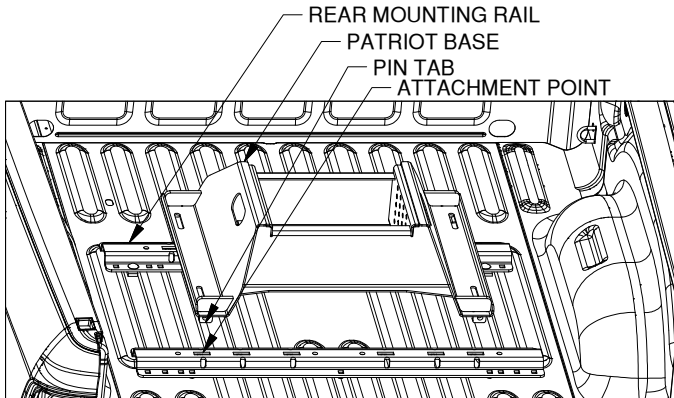

Figure C1: View into truck bed looking toward tailgate.

IMPORTANT: Before drilling rear mounting holes pull the RV base towards the cab of the truck and push the rear rail towards the rear of the truck to correctly space the mounting rails, see Figure C2.

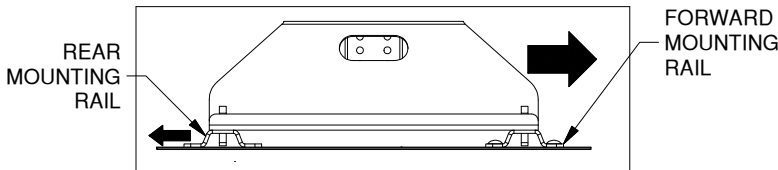

Figure C2: Side view of RV base and mounting rails.

2. **Drill rear rail mounting holes.** Using the same method as used for the forward mounting rail, mark and drill the 1/8" holes for the rear mounting rail. Refer to "DRILL FORWARD MOUNTING HOLES" section, Step 2, page 2. Notice that the hole locations are slightly different than the forward rail, see Figure A3 (on the second page).

NOTE: The two forward drill locations on the rear rail are directly above a bed cross member. The drill must pass through both the bed and the cross member. Holes through both the bed and cross member should be as straight as possible when drilled.

3. **Enlarge the holes.** Remove the base and move the rear rail out of the way. Using the 1/8" holes as pilots, drill out the 3 rear most drill locations with a 9/16" bit. Drill out the 2 forward drill locations with a 7/8" bit. The 7/8" holes should be in the bed only, do not drill up through bottom of the cross member.

4. **Place the rear mounting rail.** Locate the two tube spacers, place a tube spacer into each of the 7/8" drilled holes. Re-position the rear mounting rail over the drilled 9/16" and 7/8" holes in the bed. Install two 1/2" x 4-1/2" carriage bolts into the two forward drilled positions (7/8" holes over the cross member) and install three 1/2" x 2" carriage bolts through the three rear drilled positions, as shown in Figure C3. Place a U-shaped spacer between the bed and the mounting rail at the three rear drilled positions.

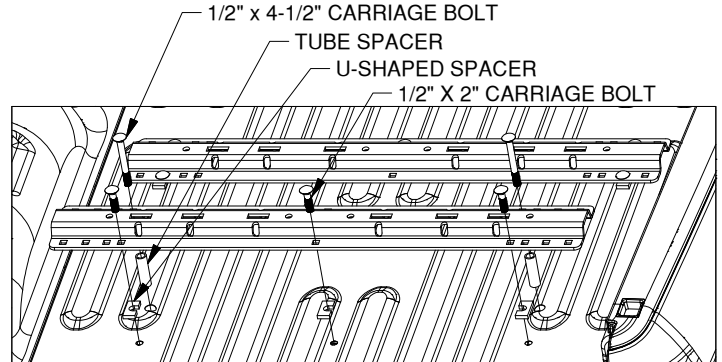

Figure C3: View looking down into the bed from rear of truck.

5. **Install the driver side rear bracket.** Locate the driver side rear bracket, two M12 x 35mm hex head bolts (shorter), two 1/2" split lock washers, and two 1/2" flat washers. Position the bracket under the installation location of the two driver side carriage bolts. Maneuver the bracket so that the 1/2" carriage bolts passes through the slots at the top of the bracket. Using 1/2" lock washers and 1/2" flat washers, thread the shorter (35mm) M12 hex head bolts into the frame through the holes in the bracket, see Figure C4.

6. **Install the passenger side rear bracket.** Locate the passenger side rear bracket, two M12 x 35mm hex head bolts (shorter), two 1/2" split lock washers, and two 1/2" flat washers. Position the bracket under the installation location of the rear passenger side carriage bolt. Maneuver the bracket so that the 1/2" carriage bolt passes through the slot at the top of the bracket. Using 1/2" lock washers and 1/2" flat washers, thread the shorter (35mm) M12 hex head bolts into the frame through the holes in the bracket, see Figure C5.

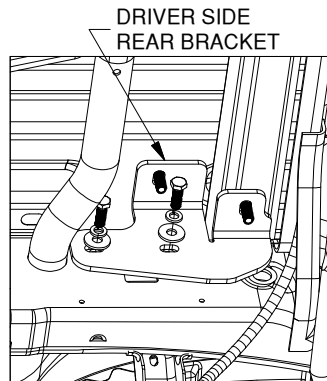

Figure C4: View looking up at driver side frame.

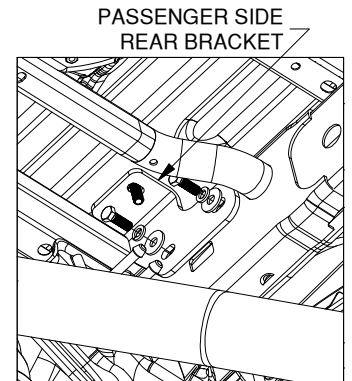

Figure C5: View looking up at passenger side frame.

7. **Fasten the rear mounting rail.** Install an offset square hole washer and 1/2" flange nut on each of the carriage bolts passing down through the bed, as shown in Figure C6. Do not tighten at this time. The passenger side 1/2" x 4-1/2" carriage bolt can be accessed from a space in the frame geometry next to the bolt, see Figure C7. Use the space to thread the offset square hole washer and 1/2" flange nut. Use a box end wrench to tighten this nut.

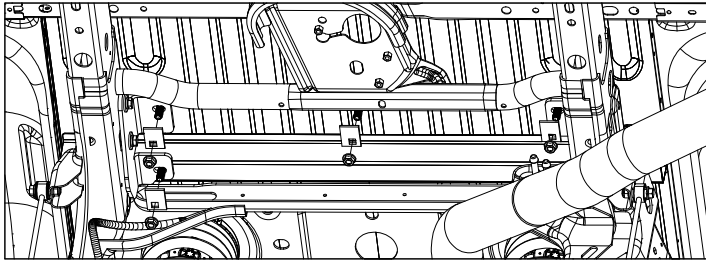

Figure C6: View looking up at the bottom of the truck bed.

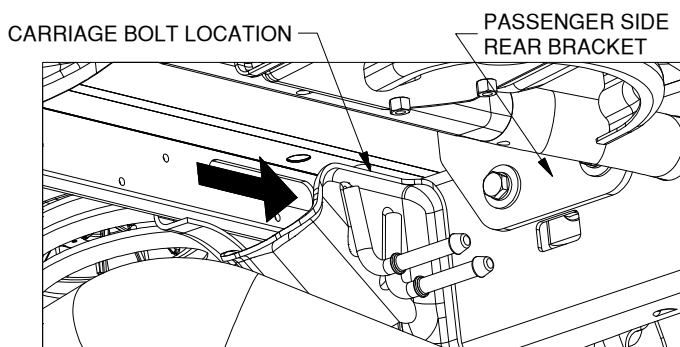

Figure C7: View looking at passenger side frame and bed cross member. Arrow indicates access area

8. **Tighten hardware.** Hand tighten all hardware. Using a torque wrench, first torque all the 1/2" nuts in the mounting rails to 80 ft-lbs. Second, torque all M12 nuts in the frame brackets to 96 ft-lbs.
9. **Secure frame elements.** If any wiring was moved or detached during installation, re-secure it to the frame. Reinstall the heat shield and spare tire, if necessary.

END OF INSTALL FOR 2014-2018 TRUCKS

INSTALL REAR MOUNTING RAIL 2019+ TRUCKS

1. **Position the rear mounting rail.** For this step the base which will be used in the mounting rails is required. Place a mounting rail into the truck bed behind the forward mounting rail. Place the base over the rail attachment points and carefully lower it until the pin tabs pass through the attachment points on the forward mounting rail. Attach the rear mounting rail to the rear mounting points on the base. The base should rest flat against the top of the rails, see Figure D1. With the base still attached, ensure that the rear rail is centered in the truck bed.

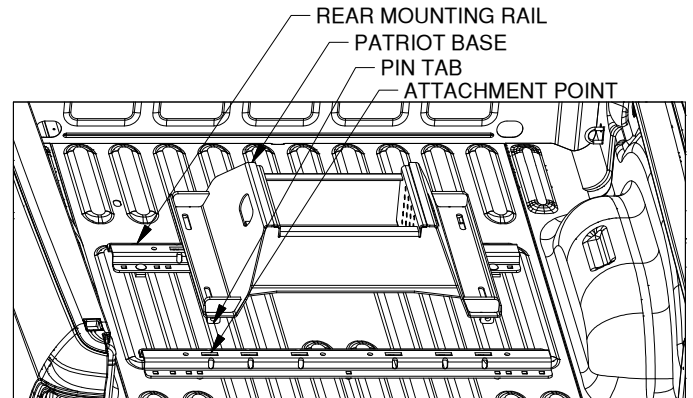

Figure D1: View into truck bed looking toward tailgate.

IMPORTANT: Before drilling rear mounting holes pull the RV base towards the cab of the truck and push the rear rail towards the rear of the truck to correctly space the mounting rails, see Figure D2.

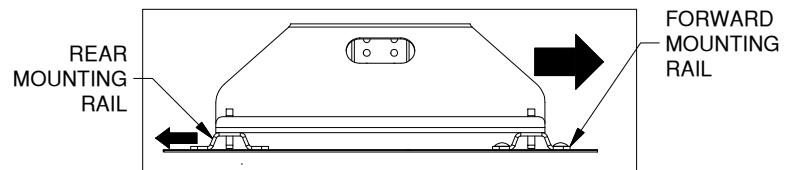

Figure D2: Side view of RV base and mounting rails.

2. **Drill rear rail mounting holes.** Using the same method as used for the forward mounting rail, mark and drill the 1/8" holes for the rear mounting rail. Refer to "DRILL FORWARD MOUNTING HOLES" section, Step 2, on page 2. Notice that the hole locations are slightly different than the forward rail, see Figure A3 (on the second page).

NOTE: The two forward drill locations on the rear rail are directly above a bed cross member. On the driver side, the drill must pass through both the bed and the cross member. The hole should be as straight as possible when drilled.

3. **Enlarge the holes.** Remove the base and move the rear rail out of the way. Using the 1/8" hole as a pilot, drill out the driver side forward drill location with a 7/8" bit. The 7/8" hole should be in the bed only, do not drill up through bottom of the cross member. Drill out the remaining 4 drill locations with a 9/16" bit.

- 4. Place the rear mounting rail.** Locate one tube spacer. Place the tube spacer into the 7/8" drilled hole. Re-position the rear mounting rail over the drilled 9/16" and 7/8" holes in the bed. Install a 1/2" x 4-1/2" carriage bolt into the driver side forward drilled position (7/8" hole over the cross member). Install three 1/2" x 2" carriage bolts through the three rear drilled positions, as shown in Figure D3. Place a U-shaped spacer between the bed and the mounting rail at the three rear drilled positions and the passenger side forward position.

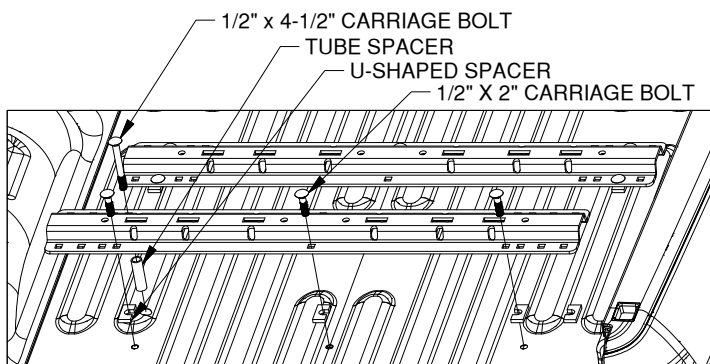

Figure D3: View looking down into the bed of the truck.

- 5. Prepare the nut guide.** A 1/2" x 2" hex head bolt and nut guide will need to be utilized to install the passenger side forward bolt. Prepare the nut guide by putting a 30° bend in the handle about 2-3/4" from the top, see Figure D4.

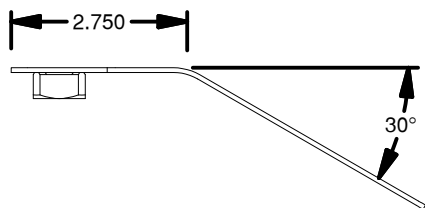

Figure D4: Bent nut guide.

- 6. Install passenger side forward bolt.** The nut guide will need to be positioned under the passenger side forward hole location with the nut on the bottom side of the guide. Insert the nut guide into the bed cross member, see Figure D5. Hold the nut under the hole while a 1/2" x 2" hex head bolt with a 1/2" lock washer is passed down through the forward mounting hole and threaded into the nut guide by another person.

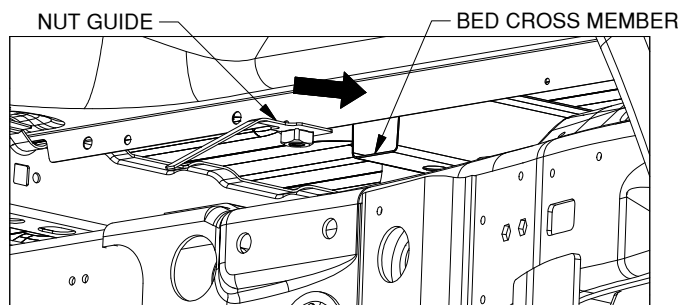

Figure D5: View looking in passenger side wheel well.

- 7. Install the driver side rear bracket.** Locate the driver side rear bracket, two M12 x 35mm hex head bolts (shorter), two 1/2" split lock washers, and two 1/2" flat washers. Position the bracket under the installation location of the two driver side carriage bolts. Maneuver the bracket so that the 1/2" carriage bolts passes through the slots at the top of the bracket. Using 1/2" lock washers and 1/2" flat washers, thread the shorter (35mm) M12 hex head bolts into the frame through the holes in the bracket, see Figure D6.

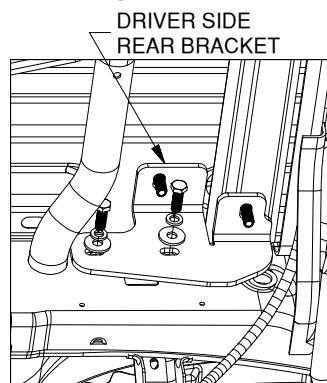

Figure D6: View looking up at driver side frame.

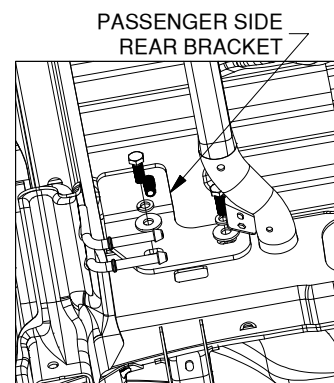

Figure D7: View looking up at passenger side frame.

- 9. Fasten the rear mounting rail.** Install an offset square hole washer and 1/2" flange nut on each of the carriage bolts passing down through the bed, as shown in Figure D8. Do not tighten at this time.

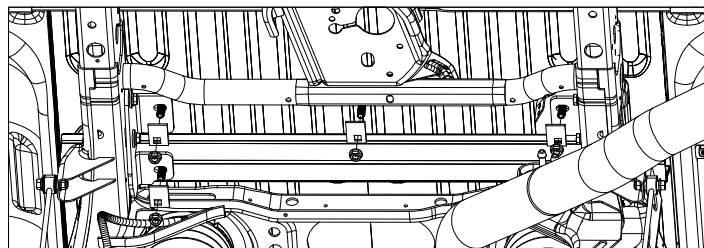

Figure D8: View looking up at the bottom of the truck bed.

- 10. Tighten hardware.** Hand tighten all hardware. Using a torque wrench, first torque all the 1/2" nuts in the mounting rails to 80 ft-lbs. Second, torque all M12 nuts in the frame brackets to 96 ft-lbs.
- 11. Secure frame elements.** If any wiring was moved or detached during installation, re-secure it to the frame. Reinstall the heat shield and spare tire, if necessary.