

<THESE INSTRUCTIONS MUST BE GIVEN TO THE END USER>



B&W Trailer Hitches
 1216 Hawaii Rd / PO Box 186
 Humboldt, KS 66748
 P:800.248.6564
 F:620.869.9031

Call or Email us for
 Installation Support
 hitches@turnoverball.com
 bwtrailerhitches.com

See Limited Lifetime Warranty at
bwtrailerhitches.com/warranty

Turnoverball® Gooseneck Hitch Installation Instructions

MODEL 1500R

FLATBED KIT

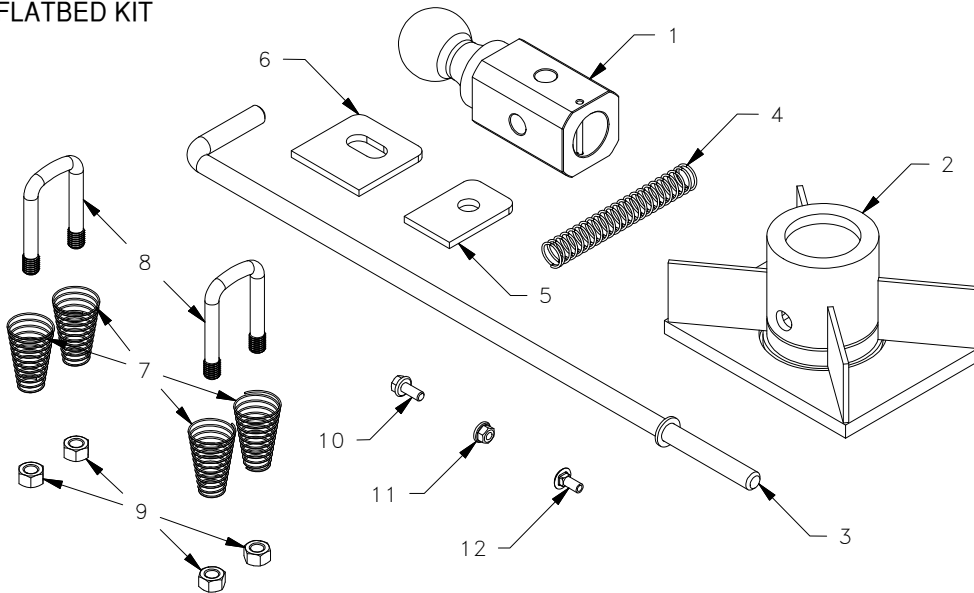

PARTS LIST (GNRK1500)		
ITEM	DESCRIPTION	QTY
1	2-5/16 Turnoverball	1
2	Flat Bed Socket Assembly	1
3	Latch Pin Handle	1
4	Compression Spring	1
5	Handle Guide With Round Hole	1
6	Handle Guide With Slotted Hole	1

SAFETY CHAIN KIT (1900-2-1600)		
ITEM	DESCRIPTION	QTY
7	Conical Spring	4
8	1-1/2" X 1-1/2" X 3-1/8" U-Bolt	2
9	1/2" Center Lock Nut	4
10	5/16" X 3/4" Flange Bolt (Not Used)	1
11	5/16" Flange Nut (Not Used)	1
12	5/16" x 3/4" Carriage Bolt (Not Used)	1

⚠ WARNING

Failure to comply with the safety information in these instructions could result in serious injury or death.

- ⚠ Read all installation and operating instructions along with all labels before using this product.
- ⚠ Adding components such as a Turnoverball hitch to the chassis of any vehicle can be hazardous. There is potential for unexpected combustion of fuel, electric shock, burns, shifting or falling of unstable vehicle, damage to vehicle, injury from tool usage and many other hazards. This installation must be completed by someone who is aware of the hazards involved. This person must be knowledgeable of proper safety procedures for a vehicle modification of this nature, and for usage of the equipment required to perform the installation.
- ⚠ On Short bed trucks, before installing this hitch, check for adequate turning clearance between the front of all of your trailers and the truck cab.
- ⚠ Do not exceed tow or tongue rating of coupler, tow or tongue rating of hitch, or tow or weight ratings of truck or trailer. See vehicle and trailer manufacturer information for ratings. Exceeding these ratings may cause damage to towing components or loss of attachment between the trailer and truck.
- ⚠ The Turnoverball hitch comes equipped with a 2-5/16" ball. Trailers towed with the ball provided must have a 2-5/16" coupler. Towing with a larger coupler could cause loss of attachment between the trailer and the tow vehicle.
- ⚠ Do not invert the ball in the socket when carrying heavy loads on two wheel drive trucks. The ball may hit the top of the differential. Remove the ball from the socket before loading. A plug for the socket is available from B&W.
- ⚠ Additional caution must be used when towing a wedge car trailer. Towing stability greatly depends on keeping the center of gravity as low as possible. Load heavy cars over the axles. Never tow with a single car on the front of the trailer. When towing a wedge car trailer, never exceed speeds that are reasonable for the roadway conditions (e.g. turns, going around a curve, etc.). Failure to account for proper trailer center of gravity and speeds that are reasonable for the roadway conditions may cause damage to the truck, trailer, towing components, and loss of attachment between the truck and trailer.
- ⚠ Do not exceed tow or tongue rating of coupler, tow or tongue rating of hitch, or tow or weight ratings of truck or trailer. See vehicle and trailer manufacturer information for ratings. Exceeding these ratings may cause damage to towing components or loss of attachment between the trailer and truck.
- ⚠ Do not modify this product in any manner. Doing so could alter its integrity and lead to a loss of attachment between the trailer and the tow vehicle.
- ⚠ Most trucks have fuel lines and/or brake lines and/or electrical wires located along the frame rails where B&W Turnoverball" hitches install. Carefully examine the location of fuel lines, brake lines and electrical wires before installation. Be certain you will not damage fuel lines, brake lines or electrical wires when positioning hitch components, drilling holes, tightening fasteners, and lifting and lowering the truck bed. The fuel tank vent, located on top of the gas tank, can be easily damaged during the installation of the hitch components. Care must be taken when positioning the front cross member and center section components.

INSTALLATION INSTRUCTIONS

NOTE: The flat bed hitch kit has been designed to be used with 1/8" thick floor plate. Because of the close tolerances between the socket and hitch ball base, welding the hitch socket should be avoided. If you weld the floor to the top of the hitch socket, reduce the heat of the weld to prevent heat distortion of the socket.

NOTE: When installing the flat bed hitch kit on aluminum beds, it is necessary to construct additional steel structures specifically designed to support the ball socket and latch handle guides. These steel structures should be attached securely enough for the latch pin mechanism to work properly and safely.

- 1. Drill the 4" hole.** To achieve proper turning clearance for most trailers, Mark the position of the receiver socket hole 2-6" forward of the axle. Do not exceed 72" from the center of the socket to the rear corner of the bed. Once the appropriate location is determined and marked, proceed to drill a 4" hole in the truck bed, see Figure 1.

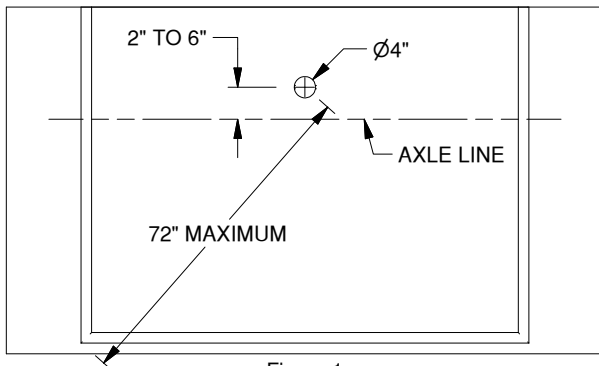

Figure 1

- 2. Install the socket.** Fit the socket into the four-inch hole as shown in Figure 2. Position the 1/2" plate so it is flat against the floor of the bed. Weld the two sides of the 1/2" plate that do not have the holes for the latch pin handle, see Figure 3.

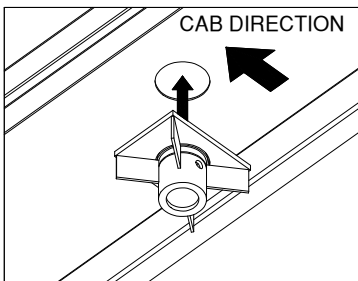

Figure 2

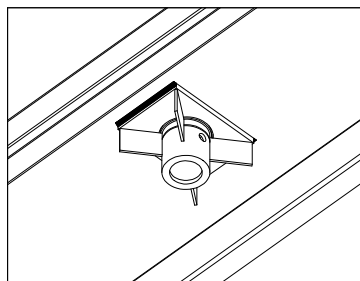

Figure 3

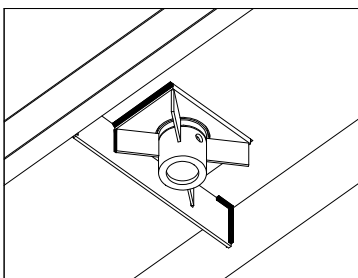

Figure 4

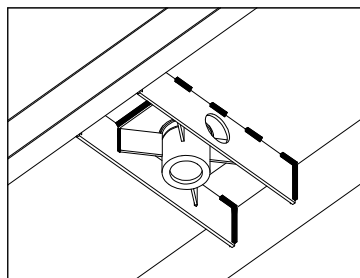

Figure 5

- 3. Install the socket braces.** Use 1/4" T x 4" W x 16" L mild steel strap (or equivalent) to brace from the truck bed C4 x 5.4" "C" channel cross members, in front of the socket assembly to the truck bed cross member rear of the socket assembly (1/4" x 4" x 16" strap not included). The 4" strap will need to have a 2-1/2" round relief hole cut on the driver side for the handle to travel through. When welding the strap, weld the fins on the socket to the strap, stitch weld the strap to the floor of the bed, and weld to the truck bed cross members, see Figures 4 & 5. Consult the B&W engineering department for an installation that deviates from our recommended installation practices or any other installation questions.

- 4. Install the latch pin handle.** Place the spring onto the latch pin handle, and then insert the handle through the handle guide with round hole. Position the handle into the hole in the receiver socket. Measure 6" from the socket to the handle guide with round hole, and weld it to the bed floor. With the latch pin handle inside the socket, place the handle guide with slotted hole onto the handle. Position the handle guide with slotted hole 16" from the socket and placed so that the handle is one one side of the slot, with the other side of the slot towards the cab. Weld the handle guide with slotted hole to the bed floor, see Figures 6 & 7.

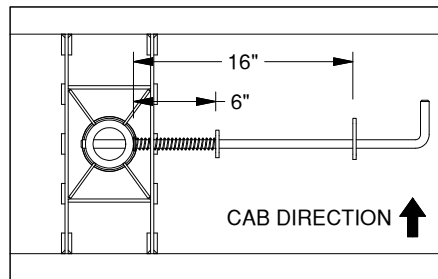

Figure 6

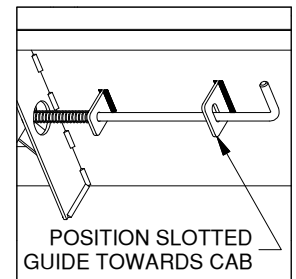

Figure 7

- 5. Install safety chain loops.** Identify locations for the safety chain loops. The loops need to be placed a minimum distance of 6-1/2" on each side of the truck's center line. If using this kit with a B&W Flatbed Companion hitch, place the safety chain loops 9" from the center line. The loops need to be placed slightly ahead of the socket. Placing the holes in a truck bed cross member is ideal. Drill two 9/16" holes on 2" centers on each side of the socket assembly, see Figure 8. Drop the safety chain loops through the holes and attach a spring and lock nut to each leg. Tighten the lock nuts until they are flush with the bottom of the U-bolt, see Figure 9.

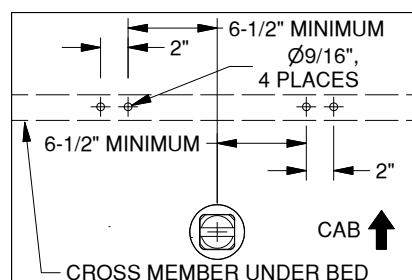

Figure 8

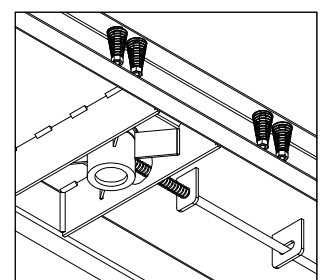

Figure 9