

### WARNING

Check with engine builder for maximum recommended safe shift point before setting shift point on tachometer. Failure to do this could lead to over-revving of engine, causing serious damage to engine and car.

### IMPORTANT NOTE

This tach has an air core meter movement. The tach pointer may not always rest at zero. This is normal. When 12V power is supplied, pointer will position to the correct rpm.

### Calibration

(Units with orange & brown loops)

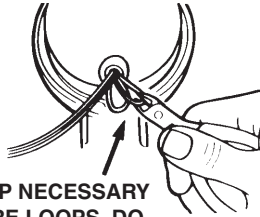

**CLIP NECESSARY WIRE LOOPS. DO NOT PUSH WIRES INTO CASE.**

- 8 CYL.**—NO adjustment is necessary.
- 6 CYL.**—Clip BROWN wire loop only. Insulate with electrical tape.
- 4 CYL.**—Clip BROWN and ORANGE wire loops. Insulate with electrical tape.

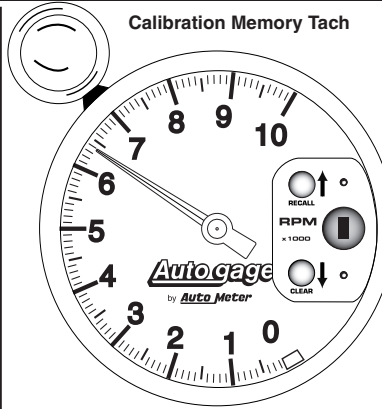

Model 233906 Shown Here

#### TYPICAL ENGINE PULSES-PER-REVOLUTION

- 4 CYL = 2 PULSE
- 6 CYL = 3 PULSE
- 8 CYL = 4 PULSE

### Cylinder Configuration

(Units without Calibration Loops)

The Cylinder Configuration mode is initiated by pressing and holding the **top button** while turning on the 12 V DC power to the gauge. **DO NOT** let go of the button until the pointer is pointing to the desired pulses per revolution for your engine application. For example, if the engine ignition puts out 4 pulses per revolution (8 cyl.), don't let go of the button until the pointer indicates "4" (thousand). See chart at right for details.

Every two seconds, the pointer will step to the next major number (2 through 4). After "4", it will start over again at "2" and keep cycling around until the button is released. If you miss it the first time around, simply wait until "your number" comes around again.

A couple of seconds after letting go of the button, the tachometer will automatically go into the normal operation mode and will permanently remember this configuration until changed again by the user.

### Mounting (Shift-Lite model shown)

- 1) Loosen both bolts holding the shock strap to the mounting foot. Back both bolts out until each is only one or two turns into the spacer.
- 2) Pass tach wires through shock strap assembly and slide tach casing into shock strap assembly.
- 3) For external Shift-Lite models, position Shift-Lite mounting bracket under shock strap as shown in image. Adjust Shift-Lite (if applicable), tach, and mounting base to desired positions (see figure 4 for recommended shock strap position), and tighten bolts holding mounting foot to shock strap to secure the assembly.
- 4) Make sure rubber section of shock strap seats properly to ensure proper fitment. Check to make sure shock strap is approximately 1 7/8" (1.875") between center line of strap and step of tachometer casing for best mounting. For external Shift-Lite models, plug shift light into tachometer connector. Plug is directional, do not force fit!
- 5) Recommended placement of external Shift-Lite (if applicable) is at 10 o'clock position. It is possible to place Shift-Lite in other positions in accordance with driver preference and vehicle mounting requirements.
- 6) The special design of the tachometer base allows for a variety of mounting possibilities. Attach the base using screws provided or use a pop rivet tool.

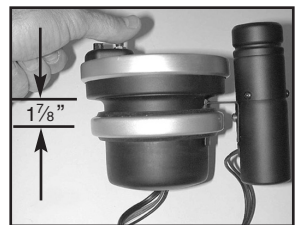
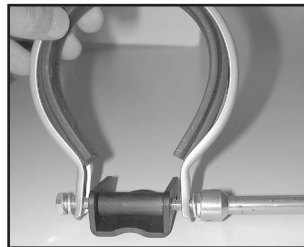

**Note:** Installation images shown may be different from your actual model.

NOTE: If your tachometer does not function correctly when connecting the green wire to an aftermarket ignition box, such as MSD, etc., it may become necessary to use an aftermarket tachometer adapter such as MSD's 8910 or 8920. Contact MSD for further details on their adapters.

### Wiring

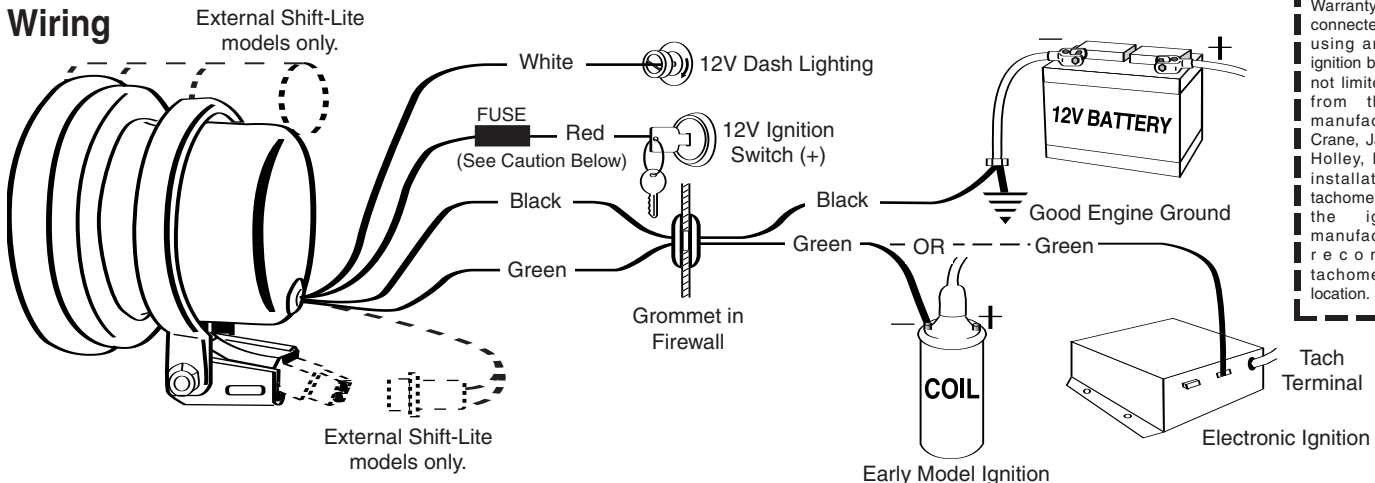

### WARNING

Warranty will be void if connected to coil when using an aftermarket ignition box such as, but not limited to products from the following manufacturers: MSD, Crane, Jacobs, Mallory, Holley, Etc.. Prior to installation of your tachometer, check with the ignition box manufacturer for recommended tachometer signal location.

- Shift-Lite connector must be plugged in prior to operation.
- Certain models feature a Shift-Lite plug and offer the option to add an external Shift-Lite.

**CAUTION!** As a safety precaution the Red wire of this product should be fused before connecting it to the positive (+) side of the 12V DC battery. We recommend using a 4 Amp, 3AG fast-acting type cartridge fuse (Littlefuse® # 312 004 or an equivalent) inline with the Red wire of our product.



## Operation (for models with Shift-Lite)

1. Turn on the power to the tach by turning the key on (Do Not start the engine). Set the desired RPM by turning the adjust knob on the tach; the pointer will move. Stop when it reaches the desired shift point.
2. Turn the power off. The tach will now use the selected shift point, until set differently.
3. During normal tachometer operation, the shift light will come on when the tachometer reaches your set point. It will stay on until the engine speed drops below the set point.

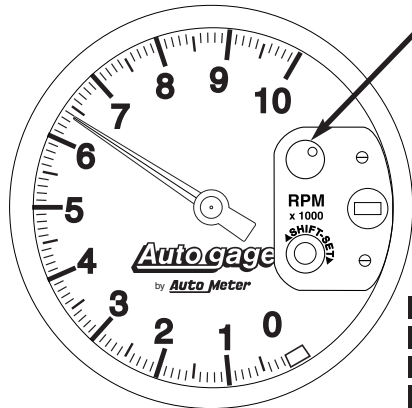

**233903 Shift-Lite:** The Shift-Lite on model 233903 is located on the dial face.

Model 233903

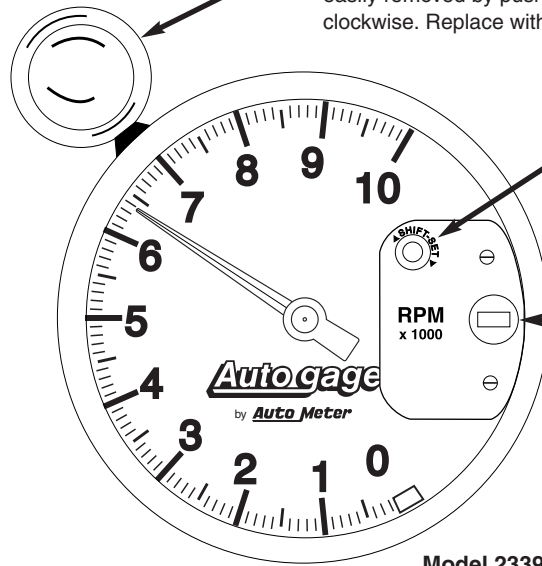

**Shift-Lite:** For shift-Lite bulb replacement, remove three screws on light. The bulb, located in the rear section, is easily removed by pushing and rotating it counter-clockwise. Replace with #1076 automotive bulb.

**Shift-Set:** To dial-in your desired shift-point turn the Shift-Set knob with power on. (See above for complete details.)

**Dial light:** For wedge base bulb replacement, order Auto Meter 3219 or GE 86 bulb. Turn socket 1/8 turn counter-clockwise to remove.

Model 233904 Shown Here

### WARNING

Check with engine builder for maximum recommended safe shift point before setting shift point on tachometer. Failure to do this could lead to over-revving of engine, causing serious damage to engine and car.

**Note:** The shift point setting can be checked anytime the vehicle is started. Turn the ignition on and the shift point setting will show on the dial.



## Operation (for models with Memory)

**Shift-Lite:** For shift-Lite bulb replacement, remove three screws on light. The bulb, located in the rear section, is easily removed by pushing and rotating it counter-clockwise. Replace with #1076 automotive bulb.

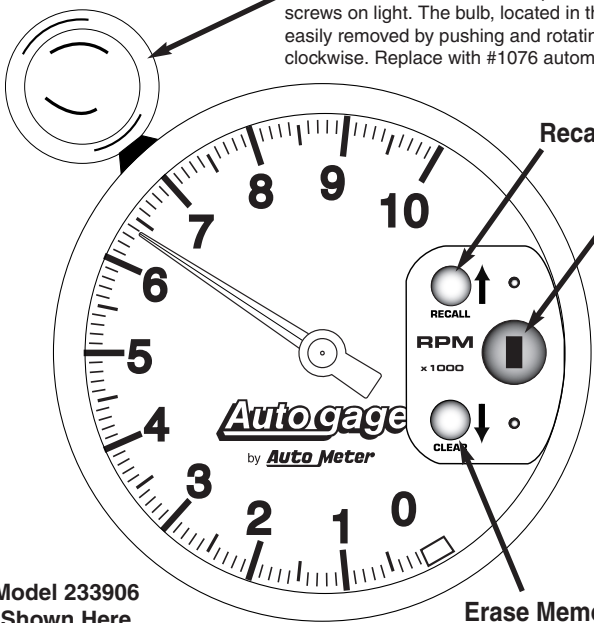

Recall RPM

**Dial light:** For wedge base bulb replacement, order Auto Meter 3219 or GE 86 bulb. Turn socket 1/8 turn counter-clockwise to remove.

Erase Memory

Model 233906 Shown Here

1. Press both buttons at the same time while in the Normal Operation mode to initiate the Shift Light Set mode.
2. The Shift Light Set mode may be identified by the shift light flashing on briefly twice per second. The pointer will display the current shift light set point.
3. Press and hold the **top button** to scan upwards (clockwise). Press and hold the **bottom button** to scan downward (counter-clockwise).
4. A brief tap on either button will cause the pointer to move slightly in the appropriate direction for fine tuning the shift point. The gauge will return to Normal Operation by simply not touching either switch for 5 seconds.

### Normal / Memory Operation

- Press and hold the **top button** to display the stored peak RPM.
- Release the button to return to normal operations.
- Press and hold the **bottom button** for a minimum of 1 second to clear the current peak memory.
- (On model 233906) Press both buttons at the same time to initiate the **SHIFT LIGHT SET** mode. (See back for details)

### WARNING

Check with engine builder for maximum recommended safe shift point before setting shift point on tachometer. Failure to do this could lead to over-revving of engine, causing serious damage to engine and car.

**Note:** When power is first applied to the tach, the Shift-Lite will light briefly to self-test the bulb and show the shift point. The shift point setting can be checked at any time there is power to the gauge. Press both buttons briefly and the shift point will display for 5 seconds.

## Autogage SERVICE

For service send your product to Auto Meter in a well packed shipping carton. Please include a note explaining what the problem is along with your phone number. Please specify when you need the product back. If you are sending product back for Warranty adjustment, you must include a copy (or original) of your sales receipt from the place of purchase.

### 12 MONTH LIMITED WARRANTY

The manufacturer warrants to the consumer that this product will be free from defects in materials and workmanship for a period of twelve (12) months from the date of the original purchase. Products that fail within this 12 month warranty period will be repaired or replaced at the manufacturer's option to the consumer, when determined by the manufacturer that the product failed because of defects in material or workmanship. This warranty is limited to the repair or replacement of parts in the instrument and the necessary labor done by the manufacturer to affect the repair or replacement of the instrument. In no event shall this warranty exceed the original purchase price of the instrument, nor shall the manufacturer be responsible for special, incidental or consequential damages or costs incurred due to failure of this product. Warranty claims to the manufacturer must be transportation prepaid and accompanied with dated proof of purchase. This warranty applies only to the original purchaser of product and is non-transferable. All implied warranties shall be limited in duration to the said 12 month warranty period. Breaking the meter seal, improper use or installation, accident, water damage, abuse, unauthorized repairs or alterations voids this warranty. The manufacturer disclaims any liability for consequential damages due to breach of any written or implied warranty on all products made by the manufacturer.

FOR SERVICE SEND TO: AUTO METER PRODUCTS, INC. 413 W. Elm St., Sycamore, IL 60178 USA (815) 899-0801

Email us at [service@autometer.com](mailto:service@autometer.com)