

AIR LIFT
PERFORMANCE

INSTALLATION GUIDE



Kit 78786

2019+ Toyota Corolla

REAR APPLICATION

For maximum effectiveness and safety, please read these instructions completely before proceeding with installation.

Failure to read these instructions can result in an incorrect installation which could result in damage to the vehicle, minor to severe personal injury or death.

Protect your Air Lift Performance Purchase by Completing your Warranty Registration

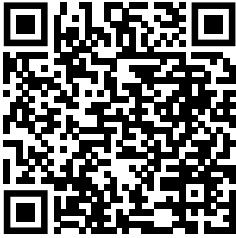

Thank you for purchasing an Air Lift Performance product!

Take a photo of your sales receipt and then scan the
QR code to complete your online warranty registration.

TABLE OF CONTENTS

P.02

Introduction

Notation Explanation

P.03

System Overview

P.04

Installing the System

Important Safety Notices

Section 1. Prepare the Vehicle

Section 2. Remove the Rear Suspension

Section 3. Install the Air Suspension

Section 4. Route the Air Lines

P.12

Before Operating

Set the Ride Height

Torque Specifications

Suggested Driving Air Pressure

Maximum Air Pressure

Check for Binding

Installation Checklist

Damping Adjustment

P.13

Limited Warranty and Return Policy

Introduction

Air Lift Performance thanks you for purchasing the most complete, fully engineered high-performance air suspension made for the 2019+ Toyota Corolla. Read these installation instructions to correctly and safely set up the vehicle for a #lifeonair.

Air Lift assumes that the installer has the mechanical knowledge and ability to work on vehicle suspension systems and has basic tools necessary to complete a suspension replacement project. Special tools needed to complete the installation are noted on the *System Overview* page.

Air Lift reserves the right to make changes and improvements to its products and publications at any time. For the latest version of this manual, contact Air Lift Performance at **(800) 248-0892** or visit **www.airliftperformance.com**.

An Air Lift Performance air management system is highly recommended for this product. Learn more at **air-lift.co/productlines**.

NOTATION EXPLANATION

Hazard notations appear in various locations in this publication. Information that is highlighted by one of these notations must be observed to help minimize risk of personal injury or possible improper installation, which may render the vehicle unsafe. Notes are used to help emphasize areas of procedural importance and provide helpful suggestions. The following definitions explain the use of these notations as they appear throughout this guide.



DANGER

INDICATES IMMEDIATE HAZARDS WHICH WILL RESULT IN SEVERE PERSONAL INJURY OR DEATH.



WARNING

INDICATES HAZARDS OR UNSAFE PRACTICES WHICH COULD RESULT IN SEVERE PERSONAL INJURY OR DEATH.



CAUTION

INDICATES HAZARDS OR UNSAFE PRACTICES WHICH COULD RESULT IN DAMAGE TO THE VEHICLE OR MINOR PERSONAL INJURY.



NOTE

Used to help emphasize areas of procedural importance and provide helpful suggestions.

System Overview

NOTE

The parts shown here are pre-assembled at the factory.

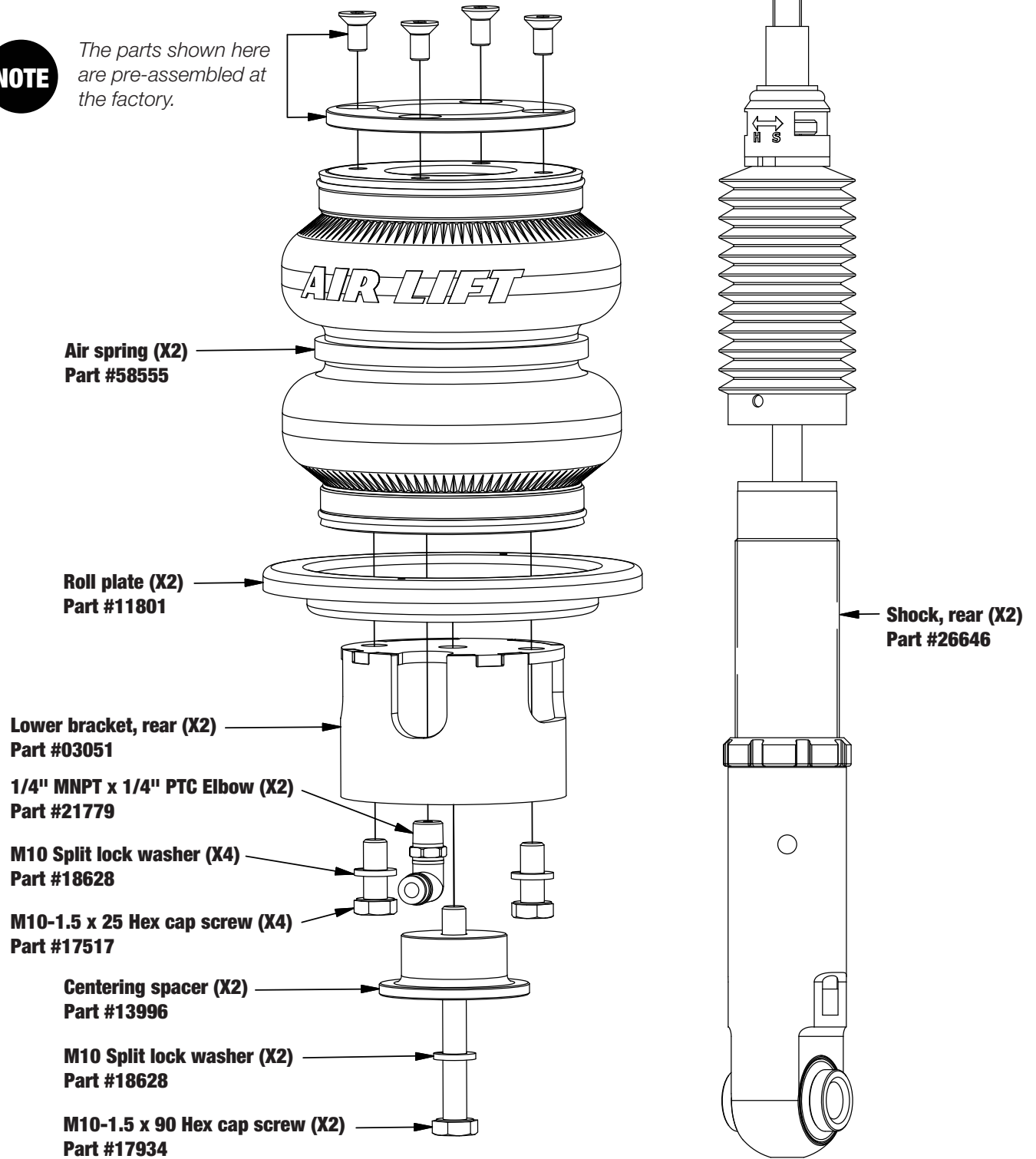

Missing or damaged parts? Call Air Lift customer service at (800) 248-0892 for a replacement part.

Installing the System

IMPORTANT SAFETY NOTICES



DO NOT INFLATE AIR SPRINGS WHILE OFF OF THE VEHICLE. DAMAGE TO ASSEMBLY MAY RESULT AND VOID WARRANTY.



DO NOT WELD TO OR MODIFY PERFORMANCE STRUTS/SHOCKS IN ANY WAY. DAMAGE TO UNIT MAY OCCUR AND WILL VOID WARRANTY.



AFTER INSTALLATION, ENSURE ALL ORIGINAL EQUIPMENT VEHICLE SAFETY FEATURES ARE PROPERLY CALIBRATED BY A QUALIFIED TECHNICIAN. CHANGING VEHICLE HEIGHT MAY AFFECT FUNCTIONING OF SAFETY SENSORS AND CAMERAS.

SECTION 1.

PREPARE THE VEHICLE



RAISE THE REAR OF THE VEHICLE AT THE APPROVED LIFTING POINTS AND USE SAFETY STANDS TO SUPPORT THE VEHICLE.

1. Elevate and support the vehicle with a hoist or safety stands.
2. Remove the front wheel. Support the lower control arm with a jack or safety stand.



THE COIL SPRING IS UNDER COMPRESSION. THE COIL SPRING SHOULD BE REMOVED USING FACTORY PRESCRIBED GUIDELINES.

SECTION 2.

REMOVE THE REAR SUSPENSION

1. Remove the lower control arm outer pivot bolt (Circled in red) and loosen the inner pivot bolt (Circled in green), but do not remove. Lower the control arm with a jack to release coil spring pressure. Remove the coil spring from the vehicle.



2. Support the rear knuckle with a jack. Remove the rear upper control arm outer pivot bolt (Circled in red).



3. Remove the lower shock mount nut (Circled in red) and the upper shock mount bolts (Circled in green).

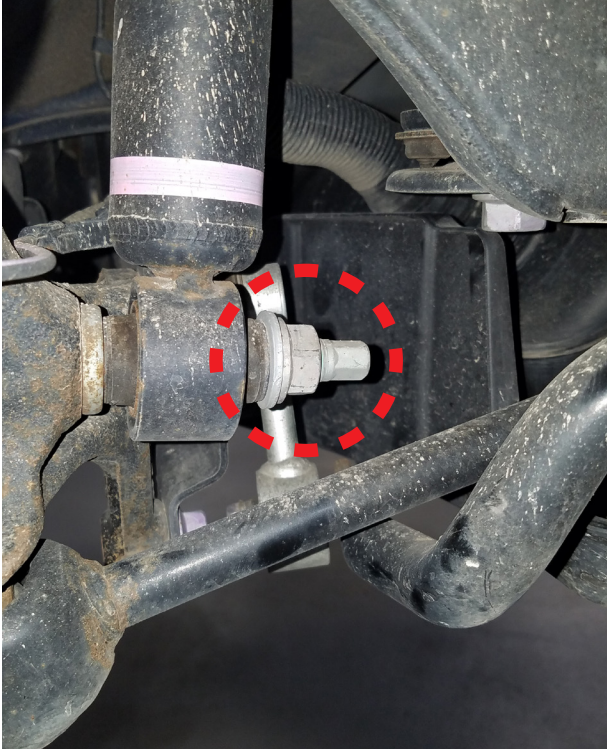

- Tilt the rear knuckle away from the vehicle to allow for removal of the rear shock.

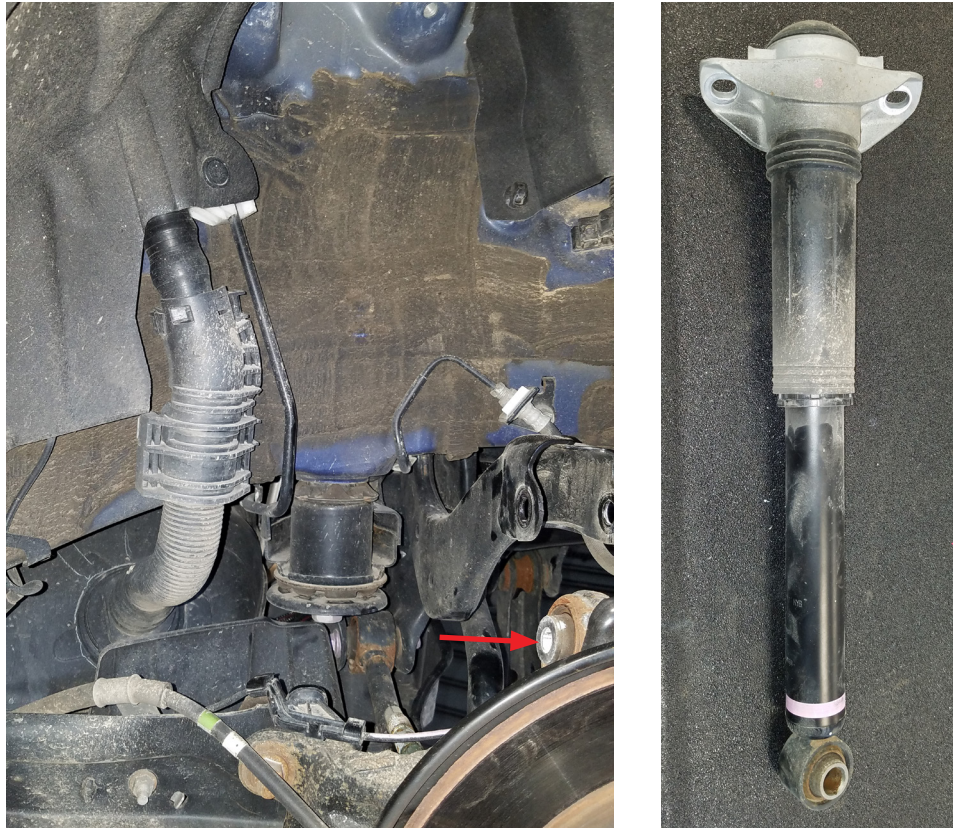

- Remove the upper shock mount dust cap, then loosen and remove the upper shock mount nut. Remove the upper mount and dust boot/jounce bumper. Separate the dust boot/jounce bumper from the upper mount.

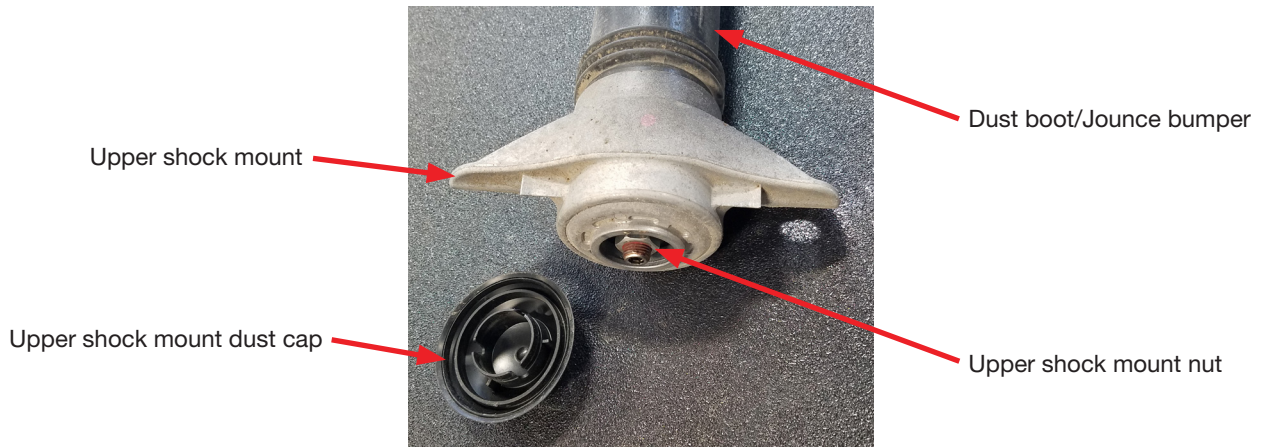

SECTION 3. INSTALL THE AIR SUSPENSION

1. Install the OEM upper shock mount on the Air Lift Performance shock. Install and torque the included nylon lock nut to 25Nm (18 lb.-ft.). Reinstall the OEM dust cap.



2. Install the Air Lift Performance lower shock mount onto the rear knuckle with the included lower mount spacers (Circled in red). Insert the upper shock mount into the chassis and install the previously removed bolts (Circled in green). Torque the upper shock mount bolts to 55Nm (41 lb.-ft.). Install the lower shock mount nut (Circled in orange) but do not torque the nut at this time.

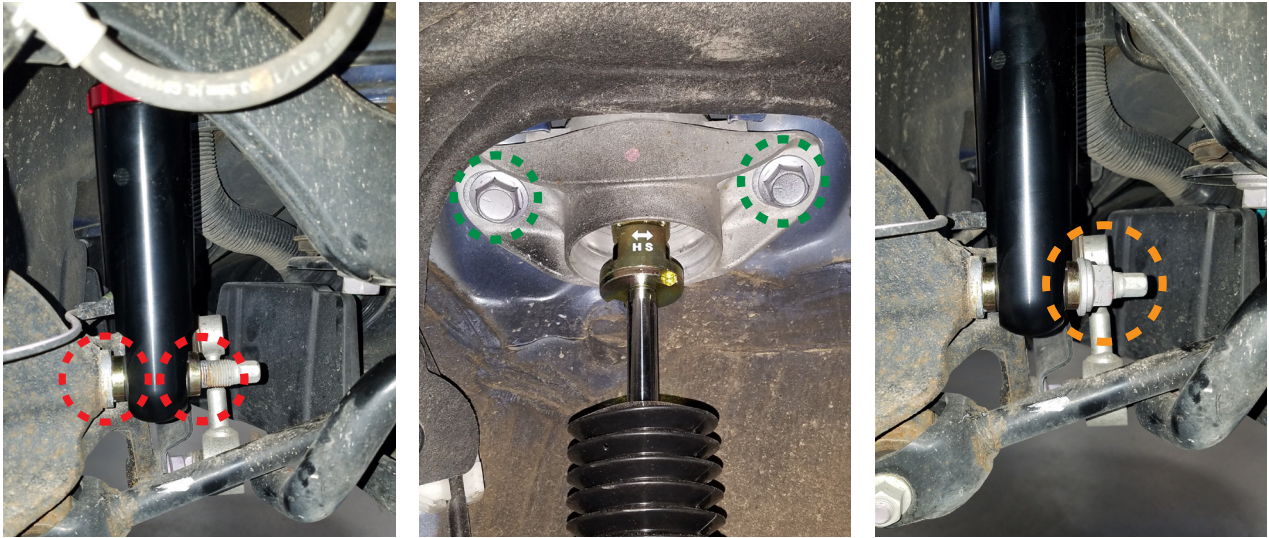

3. Reinstall the upper control arm and upper control arm outer pivot bolt (Circled in red). Ensure the bolt threads are facing the rear of the vehicle. Do not torque the bolt at this time.



4. Raise the lower control arm and reinstall the lower control arm outer pivot bolt (Circled in red). Do not torque the bolt at this time.

NOTE

Torque all hardware referenced in Section 3 (Steps 2-4) per the Torque Specifications table in the Before Operating section of this installation guide.



5. Install the elbow fitting into the air spring. Tighten the fitting 1 1/2 turns beyond hand-tight. Install a roll plate and lower air spring bracket with two M10-1.5 x 25 hex cap screw bolts and two M10 split lock washers. Torque the M10 bolts to 27Nm (20 lb.-ft.).



6. Route the air line past the inner pivot bolt and through the lower control arm. Insert the air line into the air spring fitting and place the air spring into the lower control arm.



- Center the air spring assembly in the lower control arm spring pocket. Install the centering spacer (A) with M10-1.5 x 90 hex cap screw bolt (B) and M10 split lock washer (C) and torque the bolt to 46Nm (34 lb.-ft.). Ensure the air line and fittings are still pointing inboard toward the pivot point before torquing the bolt.

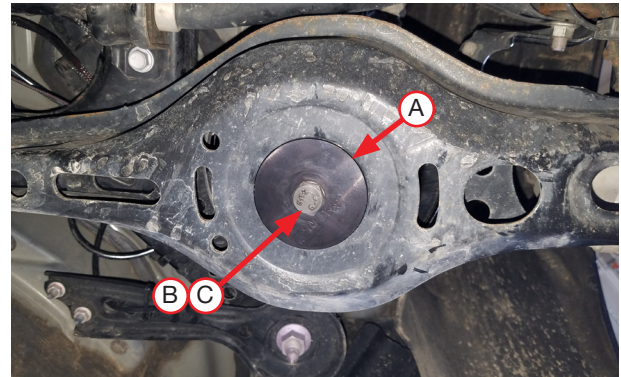

- Before reinstalling the wheel, inflate the air spring to 25 PSI (1.7BAR) to seat the upper air spring mount against the chassis.
- Torque all bolts and fasteners per the torque specifications table in the *Before Operating* section of this installation guide.
- Reinstall the wheels and torque the wheel lugnuts to 103Nm (76 lb.-ft.).



SECTION 4. ROUTE THE AIR LINES



AFTER INSTALLATION, ENSURE ALL ORIGINAL EQUIPMENT VEHICLE SAFETY FEATURES ARE PROPERLY CALIBRATED BY A QUALIFIED TECHNICIAN. CHANGING VEHICLE HEIGHT MAY AFFECT FUNCTIONING OF SAFETY SENSORS AND CAMERAS.

- Fully compress the suspension using a jack. With the suspension compressed, review the best routing for the air line that is clear of all suspension components and axle.
- Routing should allow for the suspension to extend without kinking, or pulling the line tight, or rubbing on other components. Following the brake line routing is often a good place to start. Check clearances to all other components.

Before Operating

SET THE RIDE HEIGHT

1. Refer to the User Guide supplied with this kit to set up the suspension.
2. Upon successful completion of the installation, follow these pressure requirements for the air springs.

Torque Specifications		
Location	Nm	lb.-ft.
Upper shock mount to Air Lift Performance shock	25	18
Upper shock mount to chassis bolts	55	41
Lower shock mount nut	125	92
Upper control arm outer pivot bolt	73	54
Lower control arm outer pivot bolt	73	54
Lower control arm inner pivot bolt	100	74
Air spring lower bracket bolts	27	20
Centering spacer bolt	46	34
Fitting	1 3/4 turns beyond hand-tight	
Wheel lugnuts	103	76



Suggested Driving Air Pressure



Maximum Air Pressure



FAILURE TO MAINTAIN ADEQUATE MINIMUM PRESSURE (OR PRESSURE PROPORTIONAL TO LOAD) MAY RESULT IN EXCESSIVE BOTTOMING OUT AND **WILL VOID THE WARRANTY.**

CHECK FOR BINDING



MAKE SURE THE FRONT WHEELS ARE STRAIGHT WHEN DEFLATING AND REINFLATING AIR SPRINGS.

1. Inflate and deflate the system (do not exceed 8.6BAR [125 PSI]) to check for clearance or binding issues. With the air springs deflated, check clearances on everything so as not to pinch brake lines, vent tubes, etc. Clear lines if necessary.
2. Inflate the air springs to 5.2-6.2BAR (75-90 PSI) and check all connections for leaks.

INSTALLATION CHECKLIST

- Clearance** — Inflate the air springs to 5.2-6.2BAR (75-90 PSI) and make sure there is at least 13mm (1/2") clearance from anything that might rub against the air spring. This should be checked with the air spring fully inflated and fully deflated.
- Leak** — Inflate the air springs to 5.2-6.2BAR (75-90 PSI) and check all connections for leaks. All leaks must be eliminated before the vehicle is road tested.
- Heat** — Be sure there is sufficient clearance from heat sources, at least 152mm (6") from air springs and air lines. If a heat shield was included in the kit, install it. If there is no heat shield, but one is required, call Air Lift customer service at **(800) 248-0892**.
- Fastener** — Recheck all bolts for proper torque.
- Road** — Inflate the air springs to recommended driving pressures (see previous page). Drive the vehicle 16km (10 miles) and recheck for clearance, loose fasteners, and air leaks.
- Operating instructions** — If professionally installed, the installer should review the operating instructions with the owner. Be sure to provide the owner with all paperwork that came with the kit.

DAMPING ADJUSTMENT

1. The dampers in this kit have 30 settings, or “clicks,” of adjustable compression and rebound damping characteristics. Damping is changed through the damper rod using the supplied adjuster (example shown here) or a 3mm hex key (not included).

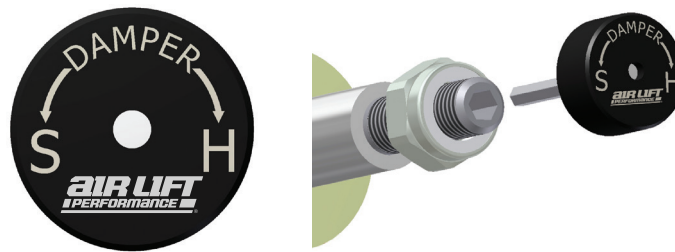

2. Turn the adjuster clockwise (H) and the damping settings are hardened, reducing oscillations and body motion. Turn the adjuster counterclockwise (S) and the damping is softened.
3. Each damper in this kit is preset to “-16 clicks.” This means that the damper is adjusted 16 clicks away from full stiff, which starts at 0. Counting up from full stiff is the preferred method of keeping track of, or setting, damping. This setting was developed on a 2020 Toyota Corolla XSE.

For more information, refer to the User Guide.

Limited Warranty and Return Policy

Air Lift Company provides a 1-year limited warranty* to the original purchaser of Air Lift Performance damper kits from the date of original purchase, that the products will be free from defects in workmanship and materials when used on cars and trucks as specified by Air Lift Company and under normal operating conditions, subject to the requirements and exclusions set forth in the full Limited Warranty and Return Policy.

* Full Limited Warranty and Return Policy are available at www.airliftperformance.com/warranty and are subject to change.

WARRANTY REGISTRATION & CLAIMS

- To register your warranty, please visit <https://www.airliftperformance.com/support/warranty-registration/>
- To submit a warranty claim, please visit <https://www.airliftperformance.com/support/submit-warranty-claim/>

Thank you for purchasing Air Lift Performance products!

Need Help?

The Air Lift Company customer service department is open from 8 a.m. to 8 p.m. ET Monday through Friday. Call (800) 248-0892 or +1 (517) 322-2144 for calls from outside the U.S. and Canada.



CONNECT BY SEARCHING FOR **AIR LIFT PERFORMANCE** #LIFEONAIR

AIR LIFT
PERFORMANCE

2727 Snow Road Lansing, MI 48917 or P.O. Box 80167 Lansing, MI 48908-0167
Toll Free (800) 248-0892 • Local (517) 322-2144 • Fax (517) 322-0240
www.airliftperformance.com



MADE IN USA
WITH GLOBAL
COMPONENTS

Air Lift Company reserves the right to make changes and improvements to its products and publications at any time. For the latest version of this manual, contact Air Lift Company at (800) 248-0892 or visit airliftperformance.com.