



Kits 78598, 78599, 78100

10th Gen Honda Civic

FRONT APPLICATION

For maximum effectiveness and safety, please read these instructions completely before proceeding with installation.

Failure to read these instructions can result in an incorrect installation which could result in damage to the vehicle, minor to severe personal injury or death.



Watch the video

Info on Table of Contents page

TABLE OF CONTENTS

P.02

Introduction

- 02. Notation Explanation
-

P.03

System Overview

P.04

Installing the System

- 04. Important Safety Notices
 - 04. Section 1. Prepare the Vehicle
 - 08. Section 2. Install the Air Suspension
 - 12. Section 3. Route the Air Lines
 - 12. Finished Installation
-

P.13

Before Operating

- 13. Set the Ride Height
 - 13. Torque Specifications
 - 13. Suggested Driving Air Pressure
 - 13. Maximum Air Pressure
 - 14. Check for Binding
 - 14. Installation Checklist
 - 14. Damping Adjustment
-

P.16

Limited Warranty and Return Policy

Video-enhanced installation guides

Visit airliftcompany.com/workshop/category/install-videos to access our installation video archive*.

* subject to availability

Introduction

Air Lift Performance thanks you for purchasing the most complete, fully engineered high-performance air suspension made for the 10th Gen Honda Civic. Read these installation instructions to correctly and safely set up the vehicle for a #lifeonair.

Air Lift assumes that the installer has the mechanical knowledge and ability to work on vehicle suspension systems and has basic tools necessary to complete a suspension replacement project. Special tools needed to complete the installation are noted on the *System Overview* page.

Air Lift reserves the right to make changes and improvements to its products and publications at any time. For the latest version of this manual, contact Air Lift Performance at **(800) 248-0892** or visit **www.airliftperformance.com**.

An Air Lift Performance air management system is highly recommended for this product. Learn more at **air-lift.co/productlines**.

NOTATION EXPLANATION

Hazard notations appear in various locations in this publication. Information which is highlighted by one of these notations must be observed to help minimize risk of personal injury or possible improper installation which may render the vehicle unsafe. Notes are used to help emphasize areas of procedural importance and provide helpful suggestions. The following definitions explain the use of these notations as they appear throughout this guide.



DANGER

INDICATES IMMEDIATE HAZARDS WHICH WILL RESULT IN SEVERE PERSONAL INJURY OR DEATH.



WARNING

INDICATES HAZARDS OR UNSAFE PRACTICES WHICH COULD RESULT IN SEVERE PERSONAL INJURY OR DEATH.



CAUTION

INDICATES HAZARDS OR UNSAFE PRACTICES WHICH COULD RESULT IN DAMAGE TO THE VEHICLE OR MINOR PERSONAL INJURY.



NOTE

Used to help emphasize areas of procedural importance and provide helpful suggestions.

System Overview

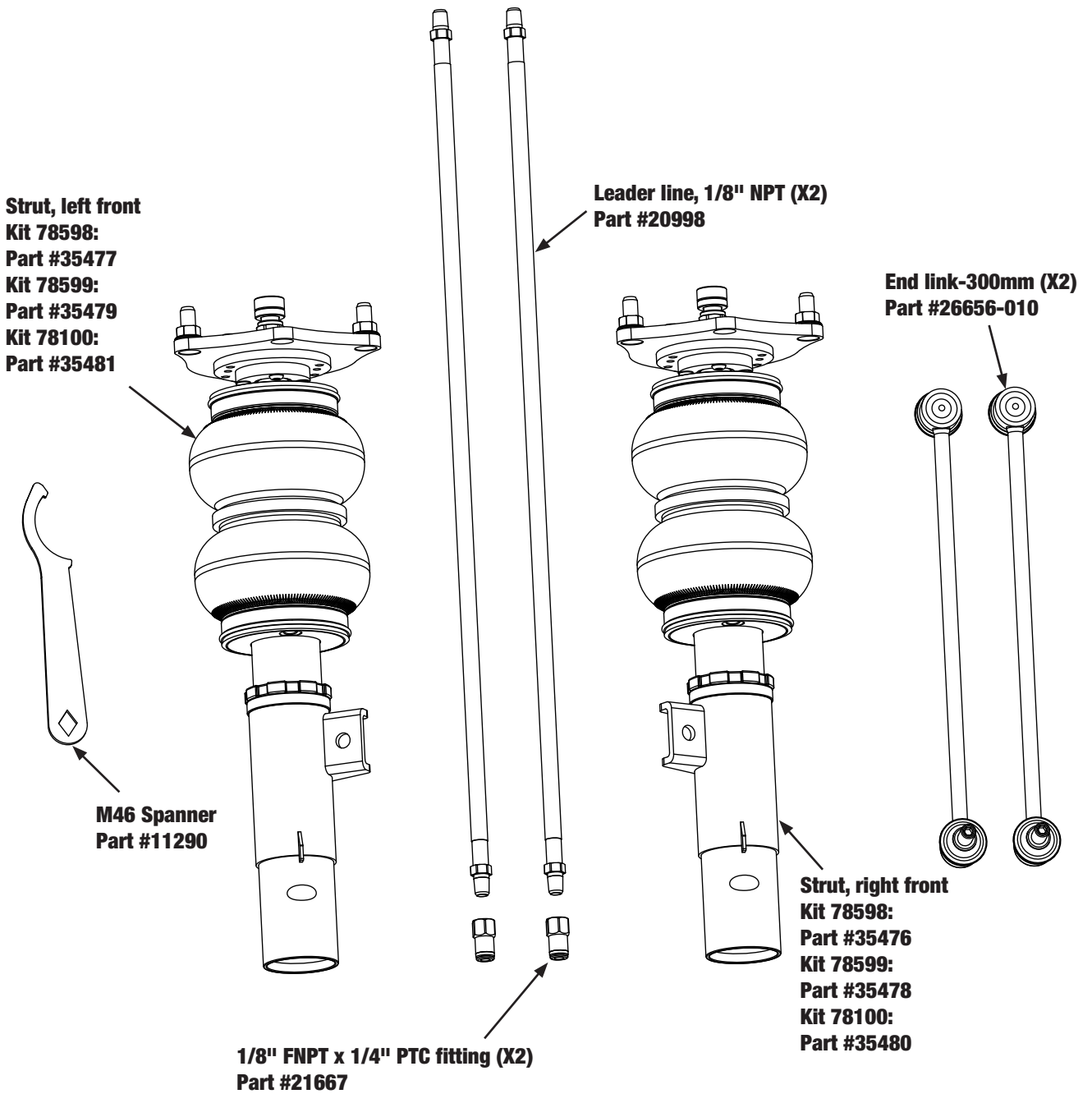

Missing or damaged parts? Call Air Lift customer service at (800) 248-0892 for a replacement part.

Installing the System

IMPORTANT SAFETY NOTICES



DO NOT INFLATE AIR SPRINGS WHILE OFF OF THE VEHICLE. DAMAGE TO ASSEMBLY MAY RESULT AND VOID WARRANTY.



DO NOT WELD TO OR MODIFY PERFORMANCE STRUTS/SHOCKS IN ANY WAY. DAMAGE TO UNIT MAY OCCUR AND WILL VOID WARRANTY.



AFTER INSTALLATION, ENSURE ALL ORIGINAL EQUIPMENT VEHICLE SAFETY FEATURES ARE PROPERLY CALIBRATED BY A QUALIFIED TECHNICIAN. CHANGING VEHICLE HEIGHT MAY AFFECT FUNCTIONING OF SAFETY SENSORS AND CAMERAS.

SECTION 1.

PREPARE THE VEHICLE



RAISE THE FRONT OF THE VEHICLE WITH A JACK AT THE APPROVED LIFTING POINTS AND USE SAFETY STANDS TO SUPPORT THE VEHICLE.

1. Raise and support the vehicle. Remove front wheel.



2. Remove stabilizer link nut from strut tab and stabilizer bar. Remove stabilizer link from vehicle.



- If the vehicle is equipped with adaptive damper system, disconnect the damper connection from the strut.



- Remove the brake hose retaining bolt.



- Remove the wheel speed sensor wire from the retainer on the strut.





SUPPORT THE BRAKE CALIPER DURING REMOVAL TO AVOID DAMAGE TO THE BRAKE HOSE.

- Loosen and remove the brake caliper bolts. Remove the brake caliper from the caliper mount.

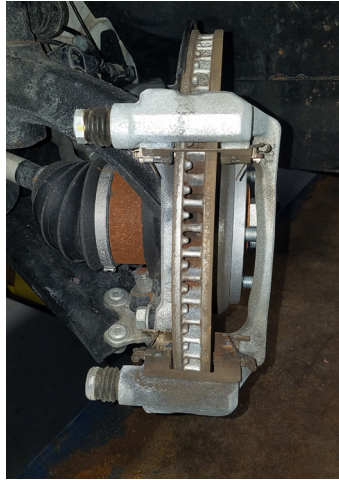

- Use a punch to push out the staked section of the spindle nut shoulder. Remove the front driveshaft spindle nut.



- Remove the tie rod nut cotter pin. Loosen tie rod end nut and separate the tie rod end from the steering knuckle.



- Remove the retaining nuts from the lower ball joint to the lower control arm. Separate the lower ball joint from the lower control arm.



DO NOT PULL THE DRIVESHAFT END OUTWARD WITH THE STEERING KNUCKLE AS IT CAN DAMAGE THE INNER DRIVESHAFT JOINT.

- Support the steering knuckle in preparation to remove it from the vehicle. Loosen and remove the damper pinch bolt. Pull the steering knuckle outward while separating the front driveshaft from the hub. Slide the steering knuckle down off the damper body and remove it from the vehicle.

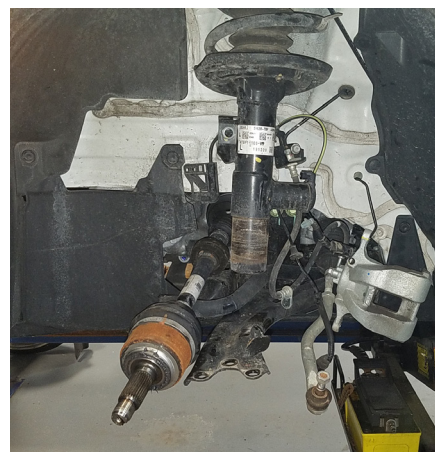
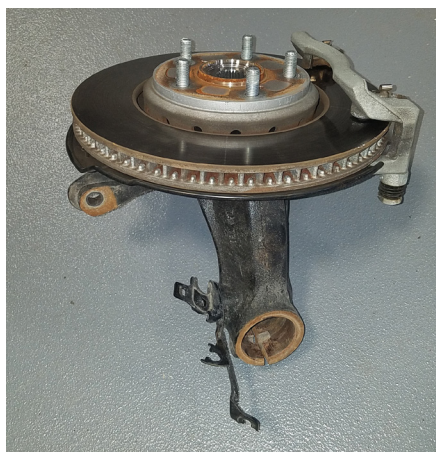

11. Remove the strut upper mount nuts and remove the strut from the vehicle.



SECTION 2.

INSTALL THE AIR SUSPENSION

1. Begin applying thread sealant to the threads of the leader line. Tighten the fitting to the air line (1 3/4 turns beyond hand-tight). Tighten the leader line into the air spring 1 3/4 turns beyond hand-tight.

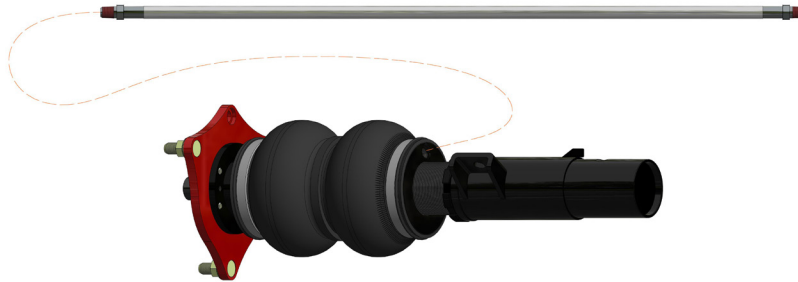

2. Insert the Air Lift Performance strut upper mount into the chassis and install the upper mount nuts. Ensure left-hand and right-hand struts are installed in the correct side. Torque the nuts to 75Nm (55 lb.-ft.).



3. Reinstall the steering knuckle by sliding it over the lower strut mount and installing the damper pinch bolt. Torque the damper pinch bolt to 80Nm (58 lb.-ft.).



4. Pull the steering knuckle outward and insert the front driveshaft through the hub. Reinstall the front driveshaft spindle nut. Do not torque the nut at this time.



5. Insert the lower ball joint studs through the lower control arm. Install the lower ball joint retaining nuts and torque them to 64Nm (47 lb.-ft.).



6. Connect the tie rod end to the steering knuckle. Install the nut and torque to 54Nm (40 lb.-ft.). Install a new cotter pin.



7. Reinstall the brake caliper on the brake caliper mounting bracket. Insert the bolts and torque them to: non-SI - 34Nm (25 lb.-ft.), SI - 50Nm (37 lb.-ft.).



8. Reinstall the brake hose retaining bolt and torque it to 22Nm (16 lb.-ft.). Place the ABS sensor wire back into the retainer.



9. Remove the protective caps and install the provided Air Lift Performance end link onto the stabilizer bar and strut body tab. Torque the nuts to 64Nm (47 lb.-ft.).



10. Torque the front driveshaft spindle nut at this time.

- 1.5L Engine – 245Nm (181 lb.-ft.)
- 2.0L Engine – 181Nm (133 lb.-ft.)

11. Using a punch, stake the spindle nut shoulder against the keyway in the axle.

SECTION 3. ROUTE THE AIR LINES



AFTER INSTALLATION, ENSURE ALL ORIGINAL EQUIPMENT VEHICLE SAFETY FEATURES ARE PROPERLY CALIBRATED BY A QUALIFIED TECHNICIAN. CHANGING VEHICLE HEIGHT MAY AFFECT FUNCTIONING OF SAFETY SENSORS AND CAMERAS.

1. Fully compress the suspension using a jack. With the suspension compressed, review the best routing for the air line that is clear of all suspension and steering components.
2. Routing should allow for the suspension to extend and steer without kinking, pulling the line tight or rubbing on other components. Following the brake line routing is often a good place to start. Check clearances to all other components.

Finished Installation

The image shows the finished installation. Note: end link is not shown installed.



Congratulations!

You are now the proud owner of an industry leading Air Lift Performance air suspension system. Enjoy!

Before Operating

SET THE RIDE HEIGHT

1. Refer to the User Guide supplied with this kit to set up the suspension.

Torque Specifications		
Location	Nm	lb.-ft.
Upper mount nuts	75	55
Damper pinch bolt	80	58
Lower ball joint nuts	64	47
Tie rod end nut	54	40
Brake caliper bolts		
Non SI	34	25
SI	50	37
Brake hose retainer bolt	22	16
Front driveshaft spindle nut		
1.5L engine	245	181
2.0L engine	181	133
Stabilizer link nuts	64	47
Lugnuts	108	80

2. Upon successful completion of the installation, follow these pressure requirements for the air springs.

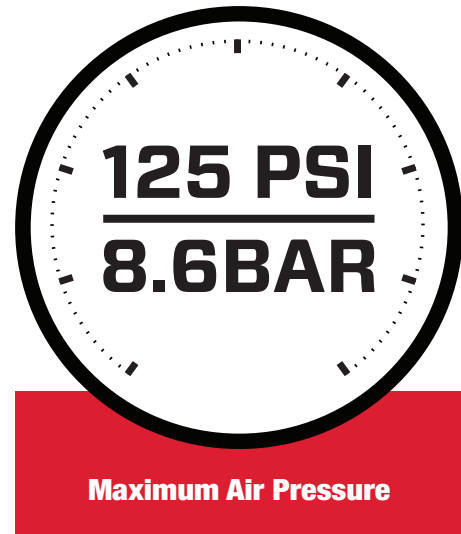
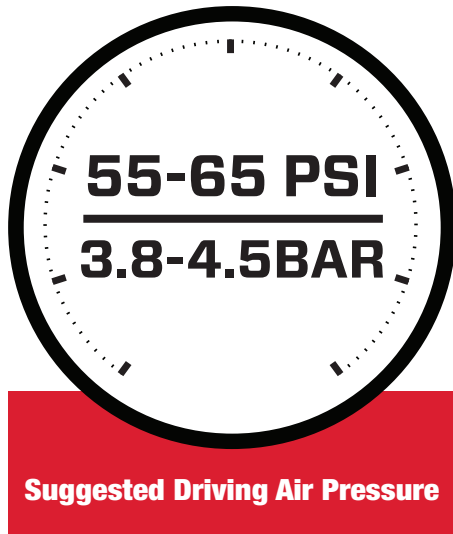

FAILURE TO MAINTAIN ADEQUATE MINIMUM PRESSURE (OR PRESSURE PROPORTIONAL TO LOAD) MAY RESULT IN EXCESSIVE BOTTOMING OUT AND **WILL VOID THE WARRANTY.**

CHECK FOR BINDING



MAKE SURE THE FRONT WHEELS ARE STRAIGHT WHEN DEFLATING AND REINFLATING AIR SPRINGS.

1. Inflate and deflate the system (do not exceed 125 PSI [8.6BAR]) to check for clearance or binding issues. With the air springs deflated, check clearances on everything so as not to pinch brake lines, vent tubes, etc. Clear lines if necessary.
2. Inflate the air springs to 75-90 PSI (5.2-6.2BAR) and check all connections for leaks.

INSTALLATION CHECKLIST

- Clearance** — Inflate the air springs to 75-90 PSI (5.2-6.2BAR) and make sure there is at least 1/2" (13mm) clearance from anything that might rub against the air spring. This should be checked with the air spring fully inflated and fully deflated.
- Leak** — Inflate the air springs to 75-90 PSI (5.2-6.2BAR) and check all connections for leaks. All leaks must be eliminated before the vehicle is road tested.
- Heat** — Be sure there is sufficient clearance from heat sources, at least 6" (152mm) from air springs and air lines. If a heat shield was included in the kit, install it. If there is no heat shield, but one is required, call Air Lift customer service at **(800) 248-0892**.
- Fastener** — Recheck all bolts for proper torque.
- Road** — Inflate the air springs to recommended driving pressures (see previous page). Drive the vehicle 10 miles (16km) and recheck for clearance, loose fasteners and air leaks.
- Operating instructions** — If professionally installed, the installer should review the operating instructions with the owner. Be sure to provide the owner with all paperwork that came with the kit.

DAMPING ADJUSTMENT

1. The dampers in this kit have 30 settings, or "clicks," of adjustable compression and rebound damping characteristics. Damping is changed through the damper rod using the supplied adjuster (example shown here) or a 3mm hex key (not included).

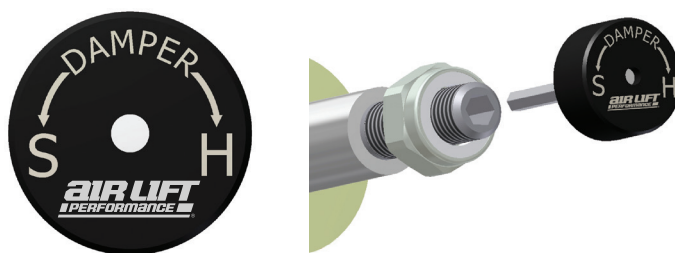

2. Turn the adjuster clockwise (H) and the damping settings are hardened, reducing oscillations and body motion. Turn the adjuster counterclockwise (S) and the damping is softened.
3. Each damper in this kit is preset to "-28 clicks." This means that the damper is adjusted 28 clicks away from full stiff, which starts at 0. Counting up from full stiff is the preferred method of keeping track of, or setting, damping. This setting was developed on a 2019 Honda Civic SI.

For more information, refer to the User Guide.

Notes

Limited Warranty and Return Policy

Air Lift Company provides a 1-year limited warranty to the original purchaser of Air Lift Performance damper kits from the date of original purchase, that the products will be free from defects in workmanship and materials when used on vehicles as specified by Air Lift Company and under normal operating conditions, subject to the requirements and exclusions set forth in the full Limited Warranty and Return Policy that is available online at www.airliftperformance.com/warranty.

For additional warranty information contact Air Lift Company customer service.

Thank you for purchasing Air Lift Performance products!

Need Help?

The Air Lift Company customer service department is open from 8 a.m. to 8 p.m. ET Monday through Friday. Call (800) 248-0892 or (517) 322-2144 for calls from outside the U.S. and Canada.



CONNECT BY SEARCHING FOR **AIR LIFT PERFORMANCE** #LIFEONAIR

AIR LIFT
PERFORMANCE

2727 Snow Road Lansing, MI 48917 or P.O. Box 80167 Lansing, MI 48908-0167
Toll Free (800) 248-0892 • Local (517) 322-2144 • Fax (517) 322-0240
www.airliftperformance.com



MADE IN USA
WITH GLOBAL
COMPONENTS

Air Lift Company reserves the right to make changes and improvements to its products and publications at any time. For the latest version of this manual, contact Air Lift Company at (800) 248-0892 or visit airliftperformance.com.